

on se mple le™



Table of Contents

General Information

| | | | |
|---|-----|------------------------------------|----|
| Freight Policy..... | 4 | Warranty Statement | 9 |
| Customer's Own Material Program..... | 5-6 | Quality Statement..... | 10 |
| Non-Standard Laminate (HPL) Program.... | 7-8 | Chair Features & Adjustments | 11 |

Seating

Stack

| | |
|---------------------------|----|
| Arcozi Four-Leg | 12 |
| Arcozi Sled | 12 |
| Arcozi Bistro-Height..... | 14 |

Guest

| | |
|--------------------|----|
| Arcozi Guest..... | 13 |
| Enclude Guest..... | 17 |

Task

| | |
|--------------------------|----|
| Arcozi Task..... | 13 |
| Arcozi Classroom..... | 14 |
| Enclude Basic Task..... | 16 |
| Enclude Deluxe Task..... | 16 |
| Cohere | 18 |

Conference

| | |
|--------------------------|----|
| Enclude Conference | 17 |
|--------------------------|----|

Stools

| | |
|-----------------------------------|----|
| Arcozi Task Stool..... | 13 |
| Arcozi Bistro-Height..... | 14 |
| Enclude Multi-Purpose Stool | 17 |
| Welle..... | 18 |

Lounge

| | |
|-----------|----|
| Murj..... | 19 |
|-----------|----|

Tables

Multi-Purpose

| | |
|-------------|----|
| Akord | 21 |
| Jibe..... | 25 |

Flip & Nest

| | |
|------------------|----|
| Akord Flip | 21 |
|------------------|----|

Conference

| | |
|-----------------------|----|
| Akord Conference..... | 23 |
|-----------------------|----|

Cafe

| | |
|-------------|----|
| Akord | 23 |
|-------------|----|

Bar & Bistro

| | |
|------------|----|
| Jibe | 25 |
|------------|----|

Occasional

| | |
|---------------|----|
| Konverg | 26 |
|---------------|----|

Specialty

| | |
|-------------|-------|
| Unyon | 30-32 |
| Modix..... | 35-44 |

Table Accessories

| | |
|-----------------------|----|
| Cord Management | 24 |
| Desk Screen | 24 |
| Modesty Panel..... | 24 |
| Power..... | 24 |

Workstations

Desks

| | |
|-------------|-------|
| Akord | 22 |
| Modix | 35-45 |

Storage

| | |
|------------|----|
| Vybe | 33 |
|------------|----|

Accessories

| | |
|---------------------------|----|
| Modesty Panel | 24 |
| Accend Monitor Lift | 27 |
| Desk Screen | 29 |
| Peg Board | 33 |

Storage

Personal

| | |
|---------------|----|
| Atytude | 33 |
| Mobee | 33 |
| Sphyr | 33 |
| Vybe | 33 |

Communal

| | |
|-------------|-------|
| Unyon | 30-32 |
|-------------|-------|

Ancillary

Screens

| | |
|---------------------|----|
| Floor Screens | 28 |
| Desk Screens | 29 |

Whiteboards

| | |
|------------|----|
| Idya | 27 |
|------------|----|

Organization

| | |
|-----------------|----|
| Peg Board | 33 |
|-----------------|----|

Lighting

| | |
|-------------|----|
| Lulli | 27 |
|-------------|----|

Power

| | |
|------------------|----|
| ConnecTrac | 24 |
| Table | 24 |

Ergonomics

| | |
|--------------|----|
| Accend | 27 |
|--------------|----|

Seating

| | |
|-------------------------|----|
| Mobile Chair Cart | 27 |
|-------------------------|----|

Waste & Recycling

| | |
|--------------|----|
| Stream | 34 |
|--------------|----|

Freight Policy

EFFECTIVE JANUARY 3, 2022

Prepaid on all orders of \$1,500 Net or more.

Orders less than \$1,500 Net:

LTL: \$150 Flat rate

Small Parcel: \$25 Flat rate

Orders containing both LTL and small parcel: \$150 flat rate

MINIMUM ORDERS

No minimum order requirement, however, all orders must be placed in full carton quantities.

Special routing request fees for LTL (Accessorial Charges):

- Call before Delivery - Included. Please specify at order entry.
- Lift Gate Assistance - \$125 for orders requiring a lift gate (no loading dock).
- Inside Delivery - \$50 for delivery to threshold only of first door.
 - Does not include put in place, un-carton, assembly, or trash removal.
 - Local restrictions may apply.
- Additional redelivery or storage charges may apply if special routing requests are not specified ahead of time and additional trips are required.
- Contact Customer Service at info@onsemblesolutions.com for a quote on Expedited Service (guaranteed date and time of delivery), or larger volume orders or special services requested over 2,000 lbs. Onsemble is not responsible for issues or costs arising from carrier transit delays, missed delivery appointments, etc.

Freight Damage

All shipments must be carefully inspected upon receipt by the assigned freight forwarder to ensure all items are in satisfactory condition before signing the bill of lading. If there is visible damage or shortage, it must be noted on the bill of lading. If not noted, we will be unable to file a claim with the carrier due to their policies. Visible damage or shortage must be reported within 24 hours of receipt of goods by the freight forwarder.

ORDERING INSTRUCTIONS

For inquiries regarding the specification of COM materials applied to Onsemble made to order seating solutions, contact (info@onsemblesolutions.com).

Step 1: Retrieve the necessary Onsemble made-to-order seating COM form found on page 5.

Step 2: Along with a copy of the COM form, send a 12"x12" material sample to:

909 4th St.

Milford IA, 51351.

Attention COM Receiving

Please include the model number and quantity of products required. This will allow for accurate yardage estimates.

Step 3: Upon approval of the material, please order the appropriate yardage and ship to:

909 4th St.

Milford IA, 51351.

Attention COM Receiving

Ensure the Onsemble purchase order number is included with the ship to address.

Step 4: Purchase orders will be acknowledged with production ship date.

THINGS TO KNOW

- All COM fabrics and vinyls must be approved by Onsemble and will not be scheduled for production until the entire yardage/square footage requirements have been received within the manufacturing facility.
- The COM approval process requires two business days to evaluate and process the 12"x12" material sample.
- Onsemble will not return excessive material. After 60 days from when the production order ships, any excess material will be recycled as part of our continued commitment to protecting the environment.
- Yardage requirements may vary based on several factors including:
Applied fabric direction, size, and geometry of the Onsemble product, and scale or print pattern. Yardage requirements will be conveyed to you upon approval of the 12"x12" sample. It is important to provide the product model number and units within the COM submission form. Yardage calculations are based on 54" wide materials.
- There are no minimum product unit requirements or pricing upcharges. Production lead-times vary by product. Standard warranty provisions apply.

Customer's Own Material Program - Approval Form

CUSTOMER & PRODUCT INFORMATION

| | | | |
|-----------------------|--|-------------------------------------|--|
| Date | | Customer Account Number | |
| Dealer Name | | Purchase Order Number | |
| Dealer Contact | | Onsemble Order Number, if available | |
| Street Address | | Onsemble Product Model Number | |
| City, State, Zip Code | | Onsemble Product Quantity (units) | |
| Phone Number | | | |

TEXTILE INFORMATION

| | | | |
|-----------------------|--|---|--|
| Mill | | APPLICATION | |
| Fabric Color | | Is there a desired top/bottom to the fabric? (YES/NO) | |
| Fabric Name/Number | | Is the fabric a stripe or 2-color plaid? (YES/NO) | |
| Total Yardage Shipped | | | |

TEXTILE ORIENTATION

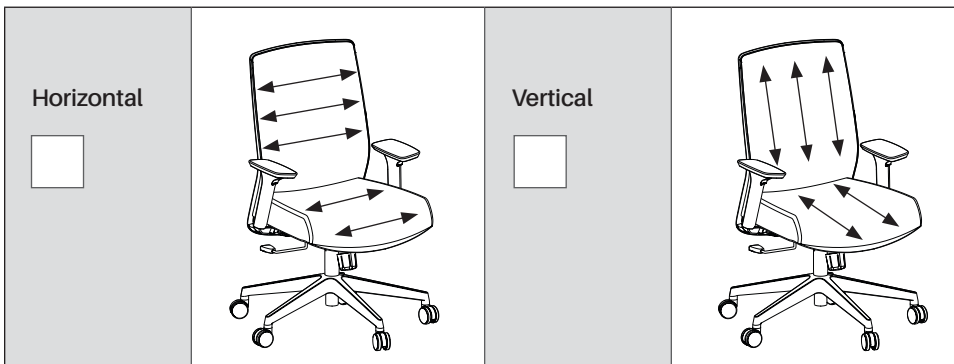

For customers requiring a specific laminate for tables, we offer an open line option through our Non-Standard Laminates program.

ORDERING INSTRUCTIONS

- Step 1:** Retrieve the necessary NSL form for specifying and placing orders from the next page.
- Step 2:** Complete the form with as much detail as possible and submit it to info@onsemblesolutions.com.
- Step 3:** We will review your submission within 5 business days and respond promptly with final list pricing.
- Step 4:** Purchase orders will be acknowledged and the production ship date will be provided.

THINGS TO KNOW

- Non-standard laminate lead times typically range from 6-8 weeks, contingent on the HPL manufacturer and laminate availability.
- Onsemble will procure the specified and approved laminate in the required quantity of sheets to fulfill your project requirements.
- Due to standard laminate sheet sizes, laminates will be applied in a horizontal orientation unless otherwise specified.
- A \$75 net per table upcharge applies to Onsemble non-standard laminates.
- For non-standard laminate upcharges for 20 tables or more, and HPL laminates with special finishes or coatings, please contact specials@onsemblesolutions.com.
- If you have any inquiries regarding special non-standard laminates, please email info@onsemblesolutions.com.

Non-Standard Laminate (HPL) Program - Request Form

Return the completed form to info@onsemblesolutions.com

CUSTOMER & PROJECT INFORMATION

| | | | |
|-----------------------|--|------------------------------------|--|
| Date | | Dealer Email | |
| Dealer Name | | Customer Account No. | |
| Dealer Contact | | Project Name | |
| Street Address | | Install Date | |
| City, State, Zip Code | | On-going Standards Program? Yes/No | |
| Phone Number | | | |

PRODUCT INFORMATION

| | |
|---------------------------------|--|
| Onsemble Model/Series Name | |
| Onsemble Model/Series Number(s) | |
| Quantity Requested | |

LAMINATE INFORMATION

| | |
|-----------------------|--|
| Laminate Manufacturer | |
| Laminate Name | |
| Laminate Number | |
| Edge Band Name | |
| Edge Band Number | |

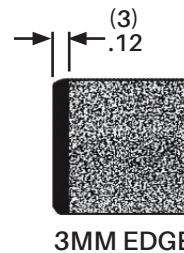

Edge Band Options

- Black (F756)
- Designer Whiter (F582)
- Ice Gray (F755)
- Warm Gray (F754)
- Taupe (F753)
- Silver (F791)
- Medium Brown (F849)
- Dark Brown (F850)
- Raven-Charcoal (F851)
- Brick (F858)
- Other:

ADDITIONAL PROJECT NOTES

1. Due to standard laminate sheet sizes, laminates will need to be applied in a horizontal orientation unless specified.
2. Onsemble non-standard laminates have a \$75 net per table up-charge.
3. Email specials@onsemblesolutions.com for non-standard laminate up-charges for 20 tables or more, and HPL laminates with special finishes.
4. For any questions about this form email info@onsemblesolutions.com.

Our warranty pledges excellence in the quality of our products. It helps protect our customer's investments and extends our continuing dedication to our customers after their initial investment.

LIMITED LIFETIME WARRANTY

Onsemble® warranty obligation: We pledge to repair or replace, at Onsemble's option, any Onsemble product or component that is defective in material or workmanship for as long as you, the original purchaser, own it. This warranty is subject to the provisions below.

LIABILITY LIMITATIONS

The following listed parts, components and supplies are covered under warranty in accordance with the below schedule following the product purchase date.

Ten Years: Seating controls and cylinders.

Five Years: Glides, casters, polymer-based components, seating upholstery (fabrics and leather), foam, armrests, chrome seating components, user-adjustable work surface mechanisms, laminates and other covering materials, drawer glides, electrical components, cabinets or mobile systems, components that are either moving parts or controls (guides that are in contact with moving parts).

Three Years: Outdoor Products, electrical components and Dry Erase Surfaces.

WARRANTY SUBJECT TO EXCLUSIONS

Exclusions pertaining to this warranty are as follows but are not limited to:

- Normal wear and tear
- Product or product components utilized with the intent to rent or lease
- Freight damages: Onsemble is not liable for any product damages sustained during shipping or handling operations. Onsemble provides specific policies and requirements regarding shipping and handling, and reserves the right to review and address product distribution matters separately.
- Product negligence: A product is not considered defective due to misuse or improper installation. Onsemble products must be installed, used and maintained
- in accordance with product instructions and warnings.
- Alterations or attachments to the product that were not approved by Onsemble
- All COM Fabric is not covered under this warranty
- All corrugated products or components
- Use of non-multiple shift products for multiple shifts
- Products purchased through a discontinued products promotion/liquidation

Onsemble's warranty obligation is limited to normal use upon receipt of our products.

SEATING USAGE

Normal commercial usage for seating is defined as the equivalent of a single shift, forty (40) hour work week. To the extent that a seating product is used in a manner exceeding this, the applicable warranty period will be reduced in a pro-rata manner.

WARRANTY PROCEDURES

Please follow the warranty procedures described below:

1. Once a defect has been discovered, the original purchaser must contact Onsemble® immediately (within 30 days of defect detection), in writing, with the serial number(s) (if applicable), date code and model number from the product(s) in question.
2. Upon inspection of the product(s), Onsemble® will collect all relevant information necessary for review of the request.
3. Product replacement and replacement parts will be authorized by a Customer Care representative if acknowledged to be necessary under product warranty eligibility conditions.

SPECIFIC LIMITATIONS REGARDING COLOR VARIATIONS, FABRICS AND FINISHES

Natural products have varying grains and colors. Due to such natural variations occurring in materials such as wood and leather, these characteristics are not considered defects. Onsemble does not warrant the color-fastness or matching of colors, grains or textures of such materials. Materials supplied, selected or provided by the customer (COM) are not warranted.

Buyer is responsible for freight to and from factory on all warranty claims. Any description of the goods sold hereunder, including any reference to Buyer's specifications and any description in catalogs, circulars and other written or digital material published by Onsemble is for the sole purpose of identifying goods and shall not create an express or implied warranty that the goods shall conform to such description.

THERE ARE NO OTHER WARRANTIES, AND Onsemble DISCLAIMS ALL IMPLIED WARRANTIES INCLUDING WARRANTIES OF MERCHANTABILITY, FITNESS FOR A PARTICULAR PURPOSE AND FREEDOM FROM PATENT INFRINGEMENT. NO AGENT, EMPLOYEE OR REPRESENTATIVE OF Onsemble HAS ANY AUTHORITY TO BIND Onsemble TO ANY AFFIRMATION, REPRESENTATION OR WARRANTY EXCEPT AS STATED HEREIN.

Onsemble SHALL HAVE NO LIABILITY FOR INDIRECT, INCIDENTAL, CONSEQUENTIAL OR SPECIAL DAMAGES OF ANY KIND. THESE LIMITATIONS ARE AGREED ALLOCATIONS OF RISK. UNDER NO CIRCUMSTANCES SHALL Onsemble's LIABILITY WITH REGARD TO THE SALE OR USE OF THE PRODUCTS EXCEED THE PURCHASE PRICE PAID BY THE BUYER FOR THE PRODUCTS. TERMS AND CONDITIONS OF THIS WARRANTY ARE SUBJECT TO CHANGE WITHOUT NOTICE.

Note: Onsemble® does not require the customer to fill out a warranty registration card. Please keep all purchase documents for the product in event the warranty is needed. Contact our Customer Care team for any warranty assistance at info@onsembleproducts.com or (877) 835-2935.

STATEMENT OF QUALITY

At Onsemble®, we understand that quality extends beyond simple function, and we are committed to the highest level of satisfaction in the manufacture, sale, and support of our products. From concept to delivery, we integrate high levels of quality as our standard and work hard to impress our customers every day. We strive for continuous improvements in all areas of product and service by regarding our quality programs as an integral part of the company's improvement process. Onsemble's quality program works to provide products that meet or exceed the quality standards our customers expect. We aim to set high environmental and safety standards by offering a large collection of third-party tested products that meet standards set forth by BIFMA, UL, the State of California, and others.

PROP 65 WARNINGS

Products with this icon  are subject to California Proposition 65. Please visit the product detail page on our website for specific information.

ENVIRONMENTAL COMMITMENTS

Onsemble not only holds itself to strict environmental standards, but we also require suppliers to follow these standards as a total supply chain initiative. Suppliers play an important role in our longstanding commitment to perform operations in a manner consistent with sound health, safety, and environmental management practices. Because of this, suppliers are not only expected to comply with applicable health, safety and environmental laws and regulations, they are expected to seek continuous improvement within these realms.

Onsemble continues to become an environmentally conscious company with the intention to offer more products that our customers can feel good about, and responsible practices that encourage sustainability, helping us obtain a proud standing in our community and the planet.

OPERATIONS

Onsemble advocates continuous improvement in the realms of efficient recycling and/or disposal of waste materials and improving treatment and control of waste emissions affecting air, water, and soil. We also encourage the practice of waste reduction operations such as machine efficiency, raw material utilization, conservation of soil, air, water quality, biodiversity, wildlife and aquatic habitats, the practice of sustainable forest management policies where applicable, end-of-life treatment recommendations, raw material and recycled content regulation, and legal compliance with environmental legislation.

DESIGN

We reserve the right to make changes in design and material, as well as discontinuance of parts and units, when such action is deemed to be an improvement in design, function and/or construction.

THE FOLLOWING ICONS ARE USED THROUGHOUT THIS PUBLICATION:



Shippable by
Small Package Carrier



PROP 65 Warning



Meets ANSI/BIFMA
Standards



Seat Height Adjustment

Quick and easy adjustment regulates height of chair relative to the floor.



Seat Glide Mechanism

Seat cushion travels forward and back, then locks into position.



Weight Sensitive Mechanism

Adjusts seat and back angles by sensing the user's body weight and reclines accordingly.



Tilt Tension

Controls rate and ease with which chair reclines to different weight and strength of users.



Tilt Lock

Locks tilt function when chair is in upright position.



Asynchronous Control

Three levers modify:

1. Angle of back relative to seat
2. Tilt (free float or infinite locking within a fixed range)
3. Forward tilt (for keyboard intensive applications)



Integral Lumbar Support

Easily adjust to enhance comfort.

There are many features to consider when selecting the perfect chair to suit your needs. The following symbols will help you choose the features that are right for you. These symbols are used throughout this pricer to help quickly identify each chair's features. The descriptions of the features shown are meant to be general explanations. The actual functions of the features may vary slightly between chair series.

Arcozi Seating Collection

ARCOZI

Poly Options

Back & Lower Back/Seat Color Options

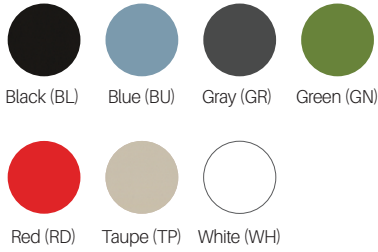

Shell Color Option Not Available. WH Only.



White (WH)

Frame Options



White Silver



Black
ACZTCH &
ACZTST only

Fabric Options

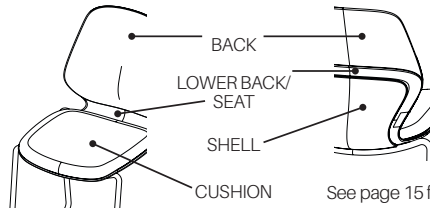

See page 15 for more chair details.

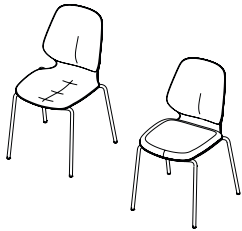

| Parent # | Description | Color | Model # | List Price Ea. | List Carton Price | Quantity Per Carton |
|----------|---|-------------|---------|----------------|-------------------|---------------------|
| ACZ4LG | Arcozi 4 Leg Stack Chair Seat Height: 19" Chair Overall: 20.75"W x 22.25"D x 34.5"H | All Poly | ACZ4LGP | 433.00 | 866.00 | 2 |
| | | Upholstered | ACZ4LGU | 572.00 | 1,144.00 | 2 |

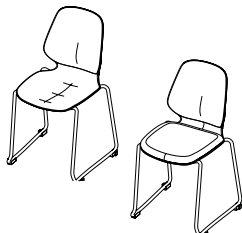

| Parent # | Description | Color | Model # | List Price Ea. | List Carton Price | Quantity Per Carton |
|----------|---|-------------|---------|----------------|-------------------|---------------------|
| ACZSLD | Arcozi Sled Base Stack Chair Seat Height: 21" Chair Overall: 21.75"W x 21.75"D x 36.5"H | All Poly | ACZSLDP | 451.00 | 902.00 | 2 |
| | | Upholstered | ACZSLDU | 590.00 | 1,180.00 | 2 |

| Model | Back Color | | Seat Color | | Upholstered Seat | Frame Color |
|--|--|--------------------------------------|--|--------------------------------------|--|-----------------------|
| ACZ4LGP - 4 Leg Stack Poly ACZ4LGU - 4 Leg Stack Uph. ACZSLDP - Sled Base Stack Poly ACZSLDU - Sled Base Stack Uph. | BL - Black BU - Blue GN - Green GR - Gray | RD - Red TP - Taupe WH - White | BL - Black BU - Blue GN - Green GR - Gray | RD - Red TP - Taupe WH - White | See above for Fabric Options *for All Poly, leave blank | SL-Silver WH-White |
| Example: ACZ4LGP + | BU + | | BU + | | OR18 + | SL |

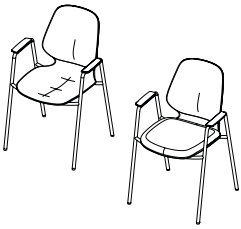

| Parent # | Description | Material | Model # | List Price |
|----------|---|-------------|---------|------------|
| ACZGCH | Arcozi Guest Chair Seat Height: 19" Chair Overall: 23.25"W x 22.25"D x 34.5"H | All Poly | ACZGCHP | 572.00 |
| | | Upholstered | ACZGCHU | 712.00 |

| Model | Back Color | Seat Color | Upholstered Seat | Frame Color |
|--|--|--------------------------------------|---|--------------------------------------|
| ACZGCHP - Arcozi Guest Chair Poly ACZGCHU - Arcozi Guest Chair Uph. | BL - Black BU - Blue GN - Green GR - Gray | RD - Red TP - Taupe WH - White | BL - Black BU - Blue GN - Green GR - Gray | RD - Red TP - Taupe WH - White |
| | | | See page page 12 for Fabric Options *for All Poly, leave blank | SL-Silver WH-White |
| Example: A C Z G C H P + | B U + | B U + | O R 1 8 + | S L |



| Parent # | Description | Material | Model # | List Price |
|----------|--|-------------|---------|------------|
| ACZTCH | Arcozi Task Chair Seat Height: 17-22" Chair Overall: 30.5"W x 30.5"D x 33-38"H | All Poly | ACZTCHP | 746.00 |
| | | Upholstered | ACZTCHU | 886.00 |

| Option | Upcharge |
|--------------------|----------|
| Seat Poly Color | N/C |
| Back Poly Color | N/C |
| Add Arms | 75.00 |
| Standard Caster | N/C |
| Hard Floor Caster | N/C |
| Hard Floor Premium | 65.00 |



| Parent # | Description | Material | Model # | List Price |
|----------|--|-------------|---------|------------|
| ACZTST | Arcozi Task Stool Seat Height: 22.25-32.25" Chair Overall: 30.5"W x 30.5"D x 38-48"H | All Poly | ACZTSTP | 903.00 |
| | | Upholstered | ACZTSTU | 1,042.00 |



| Option | Upcharge |
|--------------------|----------|
| Seat Poly Color | N/C |
| Back Poly Color | N/C |
| Add Arms | 75.00 |
| Standard Caster | N/C |
| Hard Floor Caster | N/C |
| Hard Floor Premium | 65.00 |

| Model | Back Color | Seat Color | Upholstered Fabric | Arms | Casters |
|--|--|--------------------------------|--|--------------------------------|--|
| ACZTCHP - Task Chair Poly ACZTCHU - Task Chair Uph. ACZTSTP - Task Stool Poly ACZTSTU - Task Stool Uph. | BL-Black BU-Blue GN-Green GR-Gray | RD-Red TP-Taupe WH-White | BL-Black BU-Blue GN-Green GR-Gray | RD-Red TP-Taupe WH-White | See page 12 for Fabric Options *for All Poly, leave blank |
| Example: A C Z T C H P + | B L + | B U + | O R 1 8 + | A L + | S T H F H F P |

Arcozi Seating Collection

ARCOZI

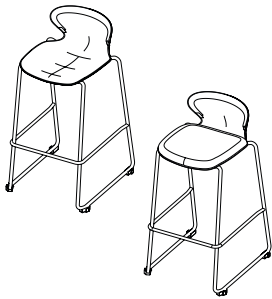

| Parent # | Description | Color | Model # | List Price Ea. | List Carton Price | Quantity Per Carton |
|----------|--|-------------|---------|----------------|-------------------|---------------------|
| ACZBST | Arcozi Bar Height Stool | All Poly | ACZBSTP | 729.00 | 1,458.00 | 2 |
| | Seat Height: 33" Chair Overall: 21.5"W x 24"D x 40.75"H | Upholstered | ACZBSTU | 868.00 | 1,736.00 | 2 |

| Model | Seat Color | Upholstered Fabric | Frame Color |
|---|--|--|-----------------------|
| ACZBSTP - Arcozi Bar Height Chair Poly ACZBSTU - Arcozi Bar Height Chair Uph | BL-Black BU-Blue GN-Green GR-Gray | RD-Red TP-Taupe WH-White | SL-Silver WH-White |
| | | See page 12 for Fabric Options *for All Poly, leave blank | |
| Example: <u>A</u> <u>C</u> <u>Z</u> <u>B</u> <u>S</u> <u>T</u> <u>P</u> + | <u>B</u> <u>U</u> + | <u>O</u> <u>R</u> <u>1</u> <u>8</u> + | <u>S</u> <u>L</u> |

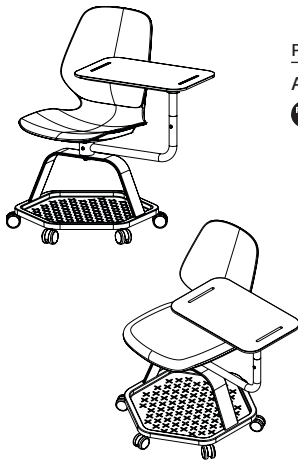

| Parent # | Description | Color | Model # | List Price |
|----------|---|-------------|---------|------------|
| ACZECH | Arcozi Education Chair Seat Height: 18.75" Chair Overall: 31.5"W x 26"D x 33.75"H | All Poly | ACZECHP | 1,184.00 |
| | | Upholstered | ACZECHU | 1,321.00 |

PROP 65

| Accessory | Charge |
|----------------------|--|
| Universal Tablet Arm | Subtract \$75 from price for No Tablet |

| Model | Back Color | Seat Color | Upholstered Fabric | Frame Color | Casters or Glides | Tablet Choice | Tablet Color | |
|---|--|--------------------------------|--|--|-----------------------|-------------------------|--------------------------------|----------------------|
| ACZECHP - Arcozi Education Chair Poly ACZECHU - Arcozi Education Chair Uph. | BL-Black BU-Blue GN-Green GR-Gray | RD-Red TP-Taupe WH-White | BL-Black BU-Blue GN-Green GR-Gray | RD-Red TP-Taupe WH-White | SL-Silver WH-White | CA-Casters GL-Glides | WT-With Tablet NT-No Tablet | BL-Black WH-White |
| | | | | See page 12 for Fabric Options *for All Poly, leave blank | | | | |
| Example: <u>A</u> <u>C</u> <u>Z</u> <u>E</u> <u>C</u> <u>H</u> <u>P</u> + | <u>B</u> <u>L</u> + | <u>B</u> <u>U</u> + | <u>O</u> <u>R</u> <u>1</u> <u>8</u> + | <u>S</u> <u>L</u> + | <u>C</u> <u>A</u> + | <u>W</u> <u>T</u> + | <u>B</u> <u>L</u> | |

- A. Back
- B. Lower Back Seat
- C. Shell
- D. Cushion (optional)
- E. Arm Pads
- F. Frame
- G. Glides
- H. Ganging Glides
- I. Arms
- J. Piston
- K. Cylinder
- L. Foot Ring
- M. 5-Star Base
- N. Casters
- O. Tablet
- P. Tablet Arm with Built-In Drink Holder
- Q. Base Shelf

Chair Details

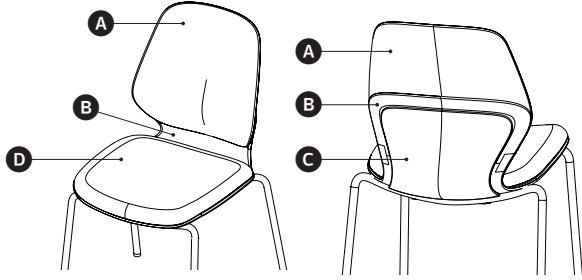

Stack Chair (4-Leg)

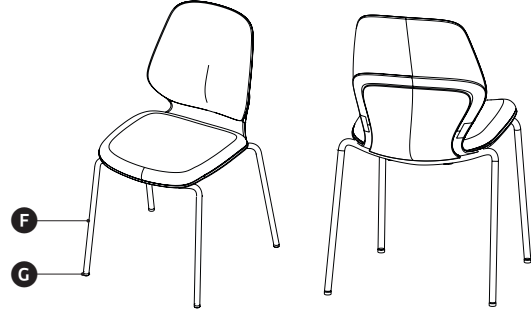

Stack Chair (Sled Base)

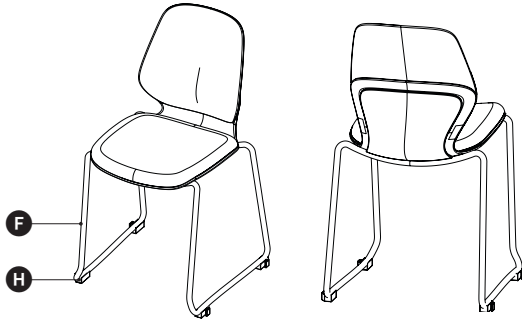

Guest Chair

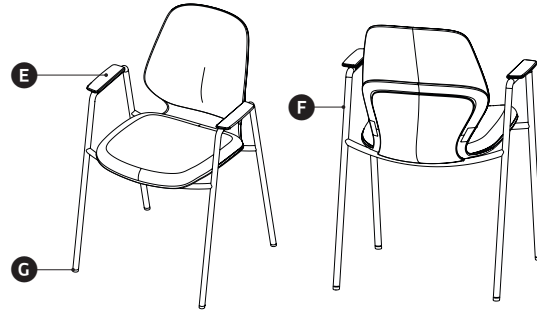

Bistro Chair

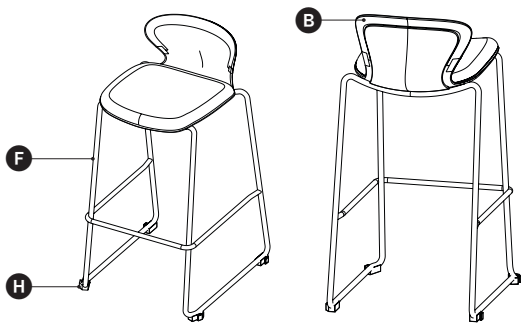

Task Chair

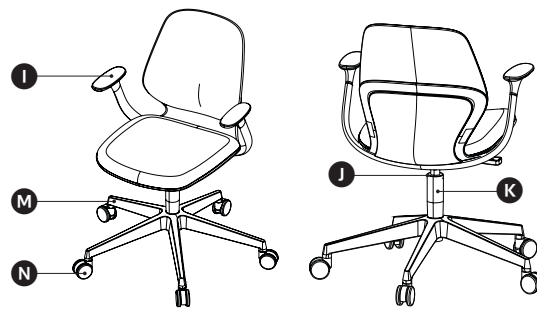

Extended-Height Chair



Education Chair

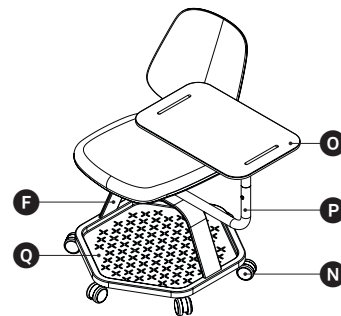

Enclude Seating Collection

ENCLUDE

Mesh Options

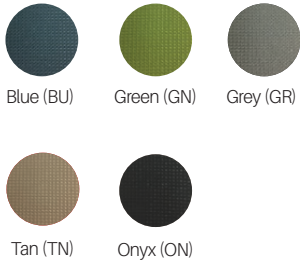

Fabric Options

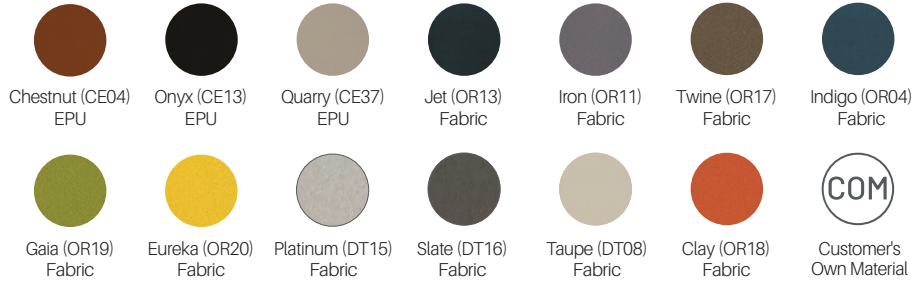

| Parent # | Description | Model # | List Price |
|----------|-------------------------------------|---------|------------|
| ECLTCHU | Enclude Task Chair 1 2 4 7 * | ECLTCHU | 988.00 |

Seat Height: 18" - 22"
 Seat: 18"W x 18"D
 Back: 17.5"W x 18.5"H
 Overall : 25"W x 25"D x 34.5" - 38"H

| Option | Upcharge |
|--------------------|----------|
| Basic Mechanism | N/C |
| Deluxe Mechanism | 355.00 |
| Headrest | 111.00 |
| Standard Caster | N/C |
| Hard Floor Caster | N/C |
| Hard Floor Premium | 65.00 |

| Model | Back Mesh | Seat Fabric | Headrest | Headrest Fabric | Mechanism | Caster Option |
|----------------------|--|------------------------------|---|---|--|---|
| ECLTCHU | BU - Blue Mesh GN - Green Mesh GR - Gray Mesh ON - Onyx Mesh TN - Tan Mesh | See above for Fabric Options | N - Without Headrest Y - With Headrest | See above for Fabric Options *for no headrest, leave blank | BM - Basic Mech ST - Deluxe Side-Tension Mech | ST - Standard Carpet HF - Hard Floor HFP - Hard Floor Premium |
| Example: ECLTCHU+ | BU+ | OR13+ | Y+ | OR13+ | ST+ | HFP |



| Parent # | Description | Model # | List Price | | | | | | | | |
|--------------------|--|---------|------------|-----------------|-----|-------------------|-----|--------------------|-------|--|--|
| ECLMSTU | Enclude Multi-Purpose Stool ① * | ECLTSTU | 1,047.00 | | | | | | | | |
| PROP 65 | Seat Height: 23"- 33" Seat: 18"W x 18"D Back: 18"W x 18"H Overall: 28"W x 28"D x 38"- 48"H | | | | | | | | | | |
| | <table border="1"> <thead> <tr> <th>Option</th> <th>Upcharge</th> </tr> </thead> <tbody> <tr> <td>Standard Caster</td> <td>N/C</td> </tr> <tr> <td>Hard Floor Caster</td> <td>N/C</td> </tr> <tr> <td>Hard Floor Premium</td> <td>65.00</td> </tr> </tbody> </table> | Option | Upcharge | Standard Caster | N/C | Hard Floor Caster | N/C | Hard Floor Premium | 65.00 | | |
| Option | Upcharge | | | | | | | | | | |
| Standard Caster | N/C | | | | | | | | | | |
| Hard Floor Caster | N/C | | | | | | | | | | |
| Hard Floor Premium | 65.00 | | | | | | | | | | |

| Model | Back Mesh | Seat Fabric | Caster Option |
|-----------------------------|--|--------------------------------|---|
| ECLTSTU | BU - Blue Mesh ON - Onyx Mesh GN - Green Mesh TN - Tan Mesh GR - Gray Mesh | See page 16 for Fabric Options | ST - Standard Carpet HF - Hard Floor HFP - Hard Floor Premium |
| Example: E C L M S T U + | B U + | O R 1 3 + | H F P |



| Parent # | Description | Model # | List Price | | | | | | | | |
|--------------------|--|---------|------------|-----------------|-----|-------------------|-----|--------------------|-------|--|--|
| ECLMCHU | Enclude Multi-Purpose Chair ① * | ECLMCHU | 901.00 | | | | | | | | |
| PROP 65 | Seat Height: 17"- 22" Seat: 18"W x 18"D Back: 18"W x 18"H Overall: 28"W x 28"D x 32"- 37"H | | | | | | | | | | |
| | <table border="1"> <thead> <tr> <th>Option</th> <th>Upcharge</th> </tr> </thead> <tbody> <tr> <td>Standard Caster</td> <td>N/C</td> </tr> <tr> <td>Hard Floor Caster</td> <td>N/C</td> </tr> <tr> <td>Hard Floor Premium</td> <td>65.00</td> </tr> </tbody> </table> | Option | Upcharge | Standard Caster | N/C | Hard Floor Caster | N/C | Hard Floor Premium | 65.00 | | |
| Option | Upcharge | | | | | | | | | | |
| Standard Caster | N/C | | | | | | | | | | |
| Hard Floor Caster | N/C | | | | | | | | | | |
| Hard Floor Premium | 65.00 | | | | | | | | | | |

| Model | Back Mesh | Seat Fabric | Caster Option |
|-----------------------------|--|--------------------------------|---|
| ECLMCHU | BU - Blue Mesh ON - Onyx Mesh GN - Green Mesh TN - Tan Mesh GR - Gray Mesh | See page 16 for Fabric Options | ST - Standard Carpet HF - Hard Floor HFP - Hard Floor Premium |
| Example: E C L M C H U + | B U + | O R 1 3 + | H F P |

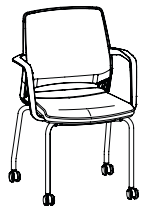

| Parent # | Description | Color | Model # | List Price Ea. | List Carton Price | Quantity Per Carton | | | | | | | | |
|--------------------|--|-------------|----------|-----------------|-------------------|---------------------|-----|--------------------|-------|--|--|--|--|--|
| ECLGCHU | Enclude Guest Chair 2/CTN | Black Frame | ECLGCHU | -- | 1,625.00 | 2 | | | | | | | | |
| PROP 65 | Seat Height: 18" Seat: 18"W x 18"D Back: 18"W x 18"H Overall: 23.5"W x 23.5"D x 33.5"H | | | | | | | | | | | | | |
| | <table border="1"> <thead> <tr> <th>Option</th> <th>Upcharge</th> </tr> </thead> <tbody> <tr> <td>Standard Caster</td> <td>N/C</td> </tr> <tr> <td>Hard Floor Caster</td> <td>N/C</td> </tr> <tr> <td>Hard Floor Premium</td> <td>65.00</td> </tr> </tbody> </table> | Option | Upcharge | Standard Caster | N/C | Hard Floor Caster | N/C | Hard Floor Premium | 65.00 | | | | | |
| Option | Upcharge | | | | | | | | | | | | | |
| Standard Caster | N/C | | | | | | | | | | | | | |
| Hard Floor Caster | N/C | | | | | | | | | | | | | |
| Hard Floor Premium | 65.00 | | | | | | | | | | | | | |

| Model | Back Mesh | Seat Fabric | Caster Option |
|-----------------------------|--|--------------------------------|---|
| ECLGCHU | BU - Blue Mesh ON - Onyx Mesh GN - Green Mesh TN - Tan Mesh GR - Gray Mesh | See page 16 for Fabric Options | ST - Standard Carpet HF - Hard Floor HFP - Hard Floor Premium |
| Example: E C L G C H U + | B U + | O R 1 3 + | H F P |

Cohere Fabric Options



Black (BL)
Fabric



Blue (BU)
Fabric



Gray (GR)
Fabric



| Parent # | Description | Color | Model # | List Price |
|----------|--|-------|-----------|------------|
| COHTCHU | Cohere Task Chair Seat Height: 20.75" Seat: 19"W x 20"D Overall: 27"W x 26"D x 44.5"H | Black | COHTCHUBL | 1,350.00 |
| | | Blue | COHTCHUBU | |
| | | Gray | COHTCHUGR | |
| | | | | |

Welle Fabric & Base Options

Black (BL)



Fabric



Plastic Base

Blue (BU)



Fabric



Plastic Base

Gray (GR)



Fabric



Plastic Base

Green (GN)



Fabric



Plastic Base

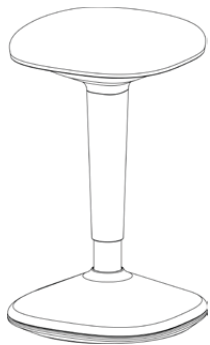

| Parent # | Description | Color | Model # | List Price |
|--|--|-------|-----------|------------|
| WELPRSU  | Welle Active Stool Seat Height: 22.75"-31.25" Overall: 13"W x 13"D x 31.25"H | Black | WELPRSUBL | 575.00 |
| | | Blue | WELPRSUBU | |
| | | Green | WELPRSUGN | |
| | | Gray | WELPRSUGR | |
| | | | | |

Fabric Options

Leg Options

HPL Laminate + Matching Edge Color Option

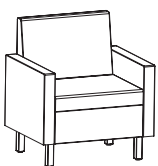

| Parent # | Description | Model # | List Price |
|----------|--|---------|------------|
| MRJL1BU | Murj Lounge Chair, Both Arms Seat: 24"W x 19"D x 18.5"H Back: 24"W x 15.25"H Arm: 6"H Overall: 30"W x 24"D x 33.75"H | MRJL1BU | 1,740.00 |

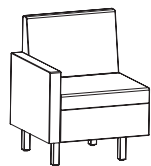

| Parent # | Description | Model # | List Price |
|----------|--|---------|------------|
| MRJL1RU | Murj Lounge Chair, Right Arm Seat: 24"W x 19"D x 18.5"H Back: 24"W x 15.25"H Arm: 6"H Overall: 27"W x 24"D x 33.75"H | MRJL1RU | 1,610.00 |

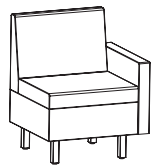

| Parent # | Description | Model # | List Price |
|----------|---|---------|------------|
| MRJL1LU | Murj Lounge Chair, Left Arm Seat: 24"W x 19"D x 18.5"H Back: 24"W x 15.25"H Arm: 6"H Overall: 27"W x 24"D x 33.75"H | MRJL1LU | 1,610.00 |

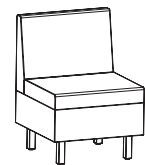

| Parent # | Description | Model # | List Price |
|----------|--|---------|------------|
| MRJL1AU | Murj Lounge Chair, Armless Seat: 24"W x 19"D x 18.5"H Back: 24"W x 15.25"H Overall: 24"W x 24"D x 33.75"H | MRJL1AU | 1,479.00 |

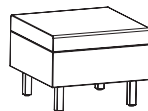

| Parent # | Description | Model # | List Price |
|----------|---|---------|------------|
| MRJL1OU | Murj Lounge Ottoman Overall: 24"W x 24"D x 18.5" | MRJL1OU | 1,218.00 |

SEATING

| Model | Fabric |
|---|---|
| MRJL1BU - Lounge Chair Both Arms MRJL1LU - Lounge Chair Left Arm MRJL1RU - Lounge Chair Right Arm MRJL1AU - Lounge Chair Armless MRJL1OU - Lounge Ottoman | DT08 - Taupe DT15 - Platinum DT16 - Slate |
| Example: MRJLGBU + | DT08 |

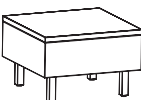

| Parent # | Description | Model # | List Price |
|----------|---|---------|------------|
| MRJL1TU | Murj Lounge Table Overall: 24"W x 24"D x 18.5" | MRJL1TU | 1,218.00 |

TABLE

| Model | Fabric | Laminate Top |
|------------------------|---|--|
| MRJL1TU - Lounge Table | DT08 - Taupe DT15 - Platinum DT16 - Slate | See above for HPL laminate with match 3mm edgeband choices |
| Example: MRJLGTU + | DT08 + | ASNT |



Laminate + Matching Edge Color Option

| | | | | |
|---|---|--|---|---|
|  Asian Night (ASNT) |  Battleship (BTTL) |  Biltmore Cherry (BMCH) |  Black (BLAK) |  Carbon Mesh (CARM) |
|  Columbian Walnut (CLWN) |  Designer White (DSWT) |  Fashion Gray (FNGY) |  Field Elm (FLEL) |  Fusion Maple (FUMP) |
|  Landmark Wood (LDMK) |  Pepperdust (PPDS) |  Pinnacle Walnut (PNWN) |  Portico Teak (PRTK) |  River Cherry (RVCH) |
|  | | | | |
| Open Line Option | | | | |

Base Color Options

| | |
|--|---|
|  White (WHIT) |  Mist (MIST) |
|  Tech Silver (TKSV) |  Corporate Sand (CSAN) |
|  Sand Beige (SDBE) |  Desert Sage (DESA) |
|  Blue Medium (BLMD) |  Textured Gray (GRAY) |
|  Black (BLCK) |  Textured Black (TBLK) |

Cutout Options

| | |
|---|--|
|  Cutout-F | "F" - \$30 List upcharge <ul style="list-style-type: none"> ▪ (1) Manufactured rectangular cutout 6.875 x 3" ▪ Grommet caps not included with cutout. |
|  Cutout-G | "G" - \$30 List upcharge <ul style="list-style-type: none"> ▪ (1) Manufactured round cutout 1.75" in diameter ▪ Includes black grommet cap. |
|  Cutout-M | "M" - \$60 List upcharge <ul style="list-style-type: none"> ▪ (2) Manufactured round cutouts 1.75" diameter ▪ Includes (2) black grommet caps. |

Laminate Edge Type

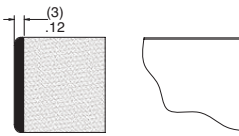

3 MM EDGE BAND

Note: All non-standard cutouts (other than above) will be reviewed to determine if the cutout does not interfere with the base, degrade table strength or cause imbalance. Contact specials@onsemblesolutions.com for quote request and drawing sign-off will be required before order is processed.

- A cohesive collection allowing specifiers to achieve a similar look throughout a space
- 1.125" thick tops with matching 3mm edge banding
- Tables available in Flip, T-Leg, Post-Leg, Café, Bistro, and Conference
- Flip tables feature dual-sided levers for a quick flip of the top
- Flip tables nest for compact storage
- Sitting-height tables are 29"H
- Bistro café tables are 42"H
- Textured SILVER powder coat bases
- Glide option includes 4 adjustable glides
- Caster options include 4 locking casters
- Manufactured cutouts and power option available

Akord Multi-Purpose Tables

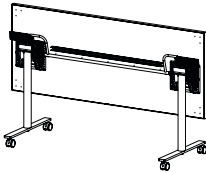
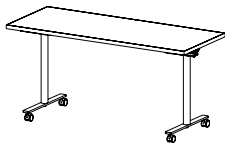

Akord Flip Base Table w/Casters

| Model | Description | List Price |
|---------------|---------------------------|------------|
| AKDFLP4818REC | Akord 48" x 18" Flip Base | 1,862.00 |
| AKDFLP4824REC | Akord 48" x 24" Flip Base | 1,909.00 |
| AKDFLP4830REC | Akord 48" x 30" Flip Base | 2,027.00 |
| AKDFLP5418REC | Akord 54" x 18" Flip Base | 1,891.00 |
| AKDFLP5424REC | Akord 54" x 24" Flip Base | 1,945.00 |
| AKDFLP5430REC | Akord 54" x 30" Flip Base | 2,085.00 |
| AKDFLP6018REC | Akord 60" x 18" Flip Base | 2,008.00 |
| AKDFLP6024REC | Akord 60" x 24" Flip Base | 2,064.00 |
| AKDFLP6030REC | Akord 60" x 30" Flip Base | 2,229.00 |

| Model | Description | List Price |
|---------------|---------------------------|------------|
| AKDFLP6618REC | Akord 66" x 18" Flip Base | 2,069.00 |
| AKDFLP6624REC | Akord 66" x 24" Flip Base | 2,123.00 |
| AKDFLP6630REC | Akord 66" x 30" Flip Base | 2,252.00 |
| AKDFLP7218REC | Akord 72" x 18" Flip Base | 2,145.00 |
| AKDFLP7224REC | Akord 72" x 24" Flip Base | 2,212.00 |
| AKDFLP7230REC | Akord 72" x 30" Flip Base | 2,372.00 |



| Model | Top Width | Top Depth | Top Shape | Leg Color | Power Cut Out | Top Color/Pattern |
|----------------------------|----------------------------|----------------|-----------------|------------------------------------|--|---|
| AKDFLP | 48 54 60 66 72 | 18 24 30 | REC - Rectangle | See page 20 for Base Color options | N - None F - Rectangle Cutout (\$30 upcharge) G - Center Rnd Cutout (\$30 upcharge) M - Left/Right Rnd Cutout (\$60 upcharge) | See page 20 for HPL laminate with matching 3mm edgeband choices |
| Example: AKDFLP+ | 60+ | 24+ | REC+ | GRAY+ | F+ | ASNT |

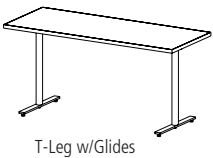

T-Leg w/Glides

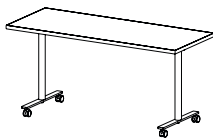

T-Leg w/Casters

Akord T-Leg Table

| Model | Description | List Price |
|---------------|-----------------------|------------|
| AKDFXT4818REC | Akord 48" x 18" T-Leg | 1,432.00 |
| AKDFXT4824REC | Akord 48" x 24" T-Leg | 1,479.00 |
| AKDFXT4830REC | Akord 48" x 30" T-Leg | 1,597.00 |
| AKDFXT5418REC | Akord 54" x 18" T-Leg | 1,462.00 |
| AKDFXT5424REC | Akord 54" x 24" T-Leg | 1,514.00 |
| AKDFXT5430REC | Akord 54" x 30" T-Leg | 1,653.00 |
| AKDFXT6018REC | Akord 60" x 18" T-Leg | 1,563.00 |
| AKDFXT6024REC | Akord 60" x 24" T-Leg | 1,618.00 |
| AKDFXT6030REC | Akord 60" x 30" T-Leg | 1,784.00 |

| Model | Description | List Price |
|---------------|-----------------------|------------|
| AKDFXT6618REC | Akord 66" x 18" T-Leg | 1,623.00 |
| AKDFXT6624REC | Akord 66" x 24" T-Leg | 1,677.00 |
| AKDFXT6630REC | Akord 66" x 30" T-Leg | 1,806.00 |
| AKDFXT7218REC | Akord 72" x 18" T-Leg | 1,653.00 |
| AKDFXT7224REC | Akord 72" x 24" T-Leg | 1,721.00 |
| AKDFXT7230REC | Akord 72" x 30" T-Leg | 1,881.00 |



| Model | Top Width | Top Depth | Top Shape | Casters/Glides | Leg Color | Power Cut Out | Top Color/Pattern |
|----------------------------|----------------------------|----------------|-----------------|-----------------------------|------------------------------------|--|---|
| AKDFXT | 48 54 60 66 72 | 18 24 30 | REC - Rectangle | CA - Casters GL - Glides | See page 20 for Base Color options | N - None F - Rectangle Cutout G - Center Rnd Cutout M - Left/Right Rnd Cutout | See page 20 for HPL laminate with matching 3mm edgeband choices |
| Example: AKDFXT+ | 60+ | 24+ | REC+ | CA+ | GRAY+ | F+ | ASNT |

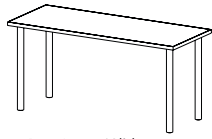

Post-Leg w/Glides

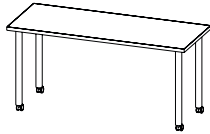

Post-Leg w/Casters

Akord Post-Leg Table

| Model | Description | List Price |
|---------------|--------------------------|------------|
| AKDFXP4818REC | Akord 48" x 18" Post Leg | 1,277.00 |
| AKDFXP4824REC | Akord 48" x 24" Post Leg | 1,324.00 |
| AKDFXP4830REC | Akord 48" x 30" Post Leg | 1,442.00 |
| AKDFXP5418REC | Akord 54" x 18" Post Leg | 1,307.00 |
| AKDFXP5424REC | Akord 54" x 24" Post Leg | 1,359.00 |
| AKDFXP5430REC | Akord 54" x 30" Post Leg | 1,498.00 |
| AKDFXP6018REC | Akord 60" x 18" Post Leg | 1,408.00 |
| AKDFXP6024REC | Akord 60" x 24" Post Leg | 1,463.00 |
| AKDFXP6030REC | Akord 60" x 30" Post Leg | 1,629.00 |

| Model | Description | List Price |
|---------------|--------------------------|------------|
| AKDFXP6618REC | Akord 66" x 18" Post Leg | 1,469.00 |
| AKDFXP6624REC | Akord 66" x 24" Post Leg | 1,523.00 |
| AKDFXP6630REC | Akord 66" x 30" Post Leg | 1,651.00 |
| AKDFXP7218REC | Akord 72" x 18" Post Leg | 1,498.00 |
| AKDFXP7224REC | Akord 72" x 24" Post Leg | 1,564.00 |
| AKDFXP7230REC | Akord 72" x 30" Post Leg | 1,726.00 |



| Model | Top Width | Top Depth | Top Shape | Casters/Glides | Leg Color | Power Cut Out | Top Color/Pattern |
|------------------------------------|----------------------------|----------------|-----------------|-----------------------------|---------------------------------------|--|--|
| AKDFXP | 48 54 60 66 72 | 18 24 30 | REC - Rectangle | CA - Casters GL - Glides | See page 20 for Base Color options | N - None F - Rectangle Cutout G - Center Rnd Cutout M - Left/Right Rnd Cutout | See page 20 for HPL laminates with matching 3mm edgeband choices |
| Example: <u>AKDFXP</u> + | <u>60</u> + | <u>24</u> + | <u>REC</u> + | <u>CA</u> + | <u>GRAY</u> + | <u>F</u> + | <u>ASNT</u> |

Akord X-Base Table

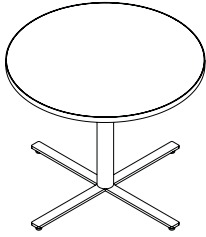

| Model | Description | List Price |
|-------------|-----------------------------------|------------|
| AKDXBB36RND | Akord 36" Round Top, X-Base 42"H | 1,608.00 |
| AKDXBB36SQR | Akord 36" Square Top, X-Base 42"H | 1,608.00 |
| AKDXBB42RND | Akord 42" Round Top, X-Base 42"H | 1,761.00 |
| AKDXBB42SQR | Akord 42" Square Top, X-Base 42"H | 1,761.00 |
| AKDXBS36RND | Akord 36" Round Top, X-Base 29"H | 1,533.00 |
| AKDXBS36SQR | Akord 36" Square Top, X-Base 29"H | 1,533.00 |
| AKDXBS42RND | Akord 42" Round Top, X-Base 29"H | 1,688.00 |
| AKDXBS42SQR | Akord 42" Square Top, X-Base 29"H | 1,688.00 |



| Model | Top Size | Top Shape | Leg Color | Top Color/Pattern |
|--|--------------|-----------------------------|---------------------------------------|--|
| AKDXBS - Sitting Height AKDXBB - Bar Height | 36 42 | RND - Round SQR - Square | See page 20 for Base Color options | See page 20 for HPL laminates with matching 3mm edgeband choices |
| Example: AKDXBS + | 3 6 + | RND + | GRAY + | ASNT |

Akord Disc-Base Table

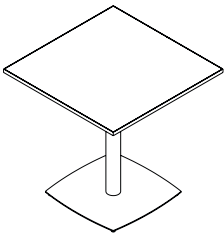

| Model | Description | List Price |
|-------------|--------------------------------------|------------|
| AKDDBB36RND | Akord 36" Round Top, Disc-Base 42"H | 1,693.00 |
| AKDDBB36SQR | Akord 36" Square Top, Disc-Base 42"H | 1,693.00 |
| AKDDBB42RND | Akord 42" Round Top, Disc-Base 42"H | 2,003.00 |
| AKDDBB42SQR | Akord 42" Square Top, Disc-Base 42"H | 2,003.00 |
| AKDDBS36RND | Akord 36" Round Top, Disc-Base 29"H | 1,620.00 |
| AKDDBS36SQR | Akord 36" Square Top, Disc-Base 29"H | 1,620.00 |
| AKDDBS42RND | Akord 42" Round Top, Disc-Base 29"H | 1,928.00 |
| AKDDBS42SQR | Akord 42" Square Top, Disc-Base 29"H | 1,928.00 |



| Model | Top Size | Top Shape | Leg Color | Top Color/Pattern |
|--|--------------|-----------------------------|---------------------------------------|--|
| AKDDBS - Sitting Height AKDDBB - Bar Height | 36 42 | RND - Round SQR - Square | See page 20 for Base Color options | See page 20 for HPL laminates with matching 3mm edgeband choices |
| Example: AKDDBS + | 3 6 + | RND + | GRAY + | ASNT |

Akord Conference Table

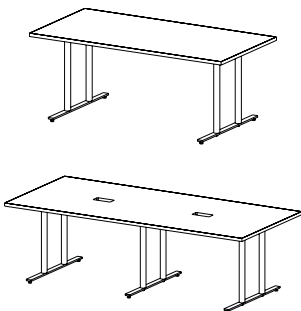

| Model | Description | List Price |
|---------------|---------------------------------|------------|
| AKDCNF7236REC | Akord 72" x 36" Conference 29"H | 2,387.00 |
| AKDCNF8442REC | Akord 84" x 42" Conference 29"H | 2,654.00 |
| AKDCNF9642REC | Akord 96" x 42" Conference 29"H | 3,537.00 |



| Model | Top Size | Top Shape | Leg Color | Power Cut Out | Top Color/Pattern |
|------------------------------------|----------------------|-----------------|---------------------------------------|----------------------------------|--|
| AKDCNF | 7236 8442 9642 | REC - Rectangle | See page 20 for Base Color options | N - None F - Rectangle Cutout | See page 20 for HPL laminates with matching 3mm edgeband choices |
| Example: AKDCNF + | 7 2 3 6 + | REC + | GRAY + | F + | ASNT |

Akord Table Collection

AKORD



PWR110V



PWRUSBAC

| Model | Description | Color | List Price |
|------------|---|-------|------------|
| PWR110VBL | Single Power Outlet | Black | 165.00 |
| PWR110VWH | Single Power Outlet | White | 165.00 |
| PWRUSBACBL | (1) USB-A/(1) USB-C Port | Black | 513.00 |
| PWRUSBACWH | (1) USB-A/(1) USB-C Port | White | 513.00 |
| PWREDGBL | NEW (2) 110V, (1) USB-A, (1) USB-C, Clamp Mount | Black | 644.00 |
| PWREDGWH | NEW (2) 110V, (1) USB-A, (1) USB-C, Clamp Mount | White | 644.00 |
| PWRISBL | NEW (2) 110V, (2) USB-A, (2) USB-C, Wall plug-In | Black | 1,018.00 |
| PWRISWH | NEW (2) 110V, (2) USB-A, (2) USB-C, Wall Plug-In | White | 1,018.00 |
| PWRISDCBL | NEW (2) 110V, (2) USB-A, (2) USB-C, Daisy Chain, 60" | Black | 1,041.00 |
| PWRISDCWH | NEW (2) 110V, (2) USB-A, (2) USB-C, Daisy Chain, 60" | White | 1,041.00 |
| PWRDCSL | NEW Daisy Chain Starter Link (Required to start chain) | | 1,122.00 |
| PWREXT | NEW Daisy Chain Extension, 12" | | 157.00 |

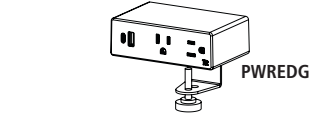

PWREDG

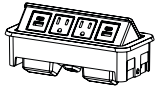

PWRIS

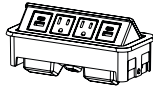

PWRISDC

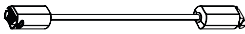
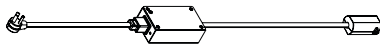

For tables greater than 60" in length:

Connect up to 8 Daisy Chain Power/Data Modules (PWRISDC) plus 12" Extension(s) (PWREXT) to each Daisy Chain Power Infeed (PWRDCSL)

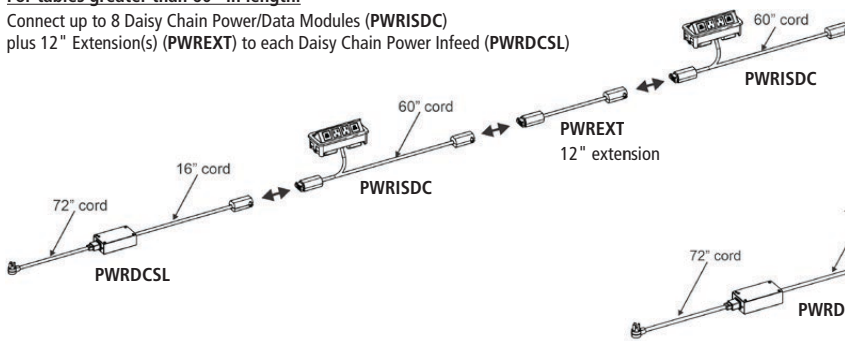

For tables 60" or shorter in length:

Connect up to 8 Daisy Chain Power/Data Modules (PWRISDC) to each Daisy Chain Power Infeed (PWRDCSL)

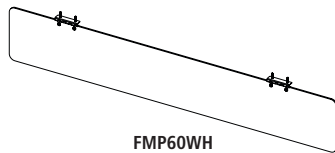
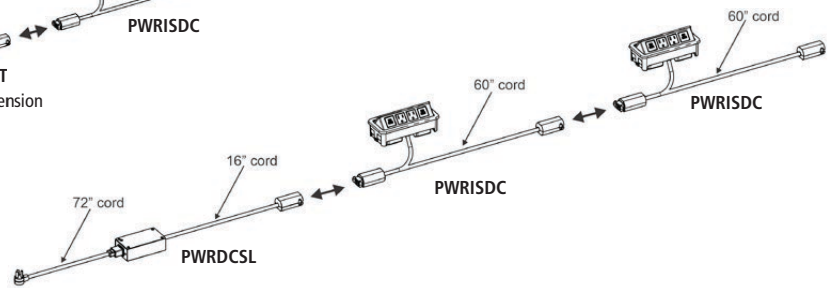

FMP60WH

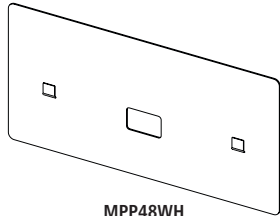

MPP48WH

| Model | Description | Size | List Price |
|------------------------|--|-----------------|------------|
| FMP48WH PROP 65 | Flip Modesty Panel for 48" and 54" Tables | 47.5"W x 11.5"H | 468.00 |
| FMP60WH PROP 65 | Flip Modesty Panel for 60" and 66" Tables | 59.5"W x 11.5"H | 510.00 |
| FMP72WH PROP 65 | Flip Modesty Panel for 72" Table | 71.5"W x 11.5"H | 505.00 |
| MPP48WH PROP 65 | Privacy Modesty Panel 48" and 54" Tables | 47.5"W x 23.5"H | 416.00 |
| MPP60WH PROP 65 | Privacy Modesty Panel for 60" and 66" Tables | 59.5"W x 23.5"H | 512.00 |
| MPP72WH PROP 65 | Privacy Modesty Panel for 72" Table | 71.5"W x 23.5"H | 611.00 |



AKDWMCSL

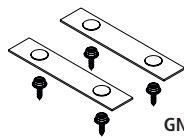

GNG1

| Model | Description | Size | List Price |
|---------------------|--|-----------------------|------------|
| AKDWMCSL NEW | Akord Wire Management Cover, Silver Finish | 2.25"W x 18"H x .25"D | 131.00 |
| GNG1 NEW | Akord Ganging Connectors, 5 sets | 5"W x 7"D | 209.00 |

Laminate + Matching Edge Color Option

Base Options

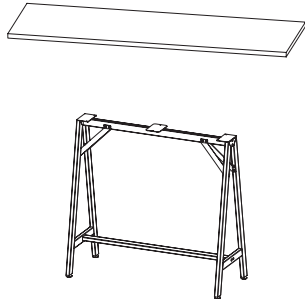

Jibe Top SKU # Formula

| Model | Top Width | Top Depth | Top Shape | Base Color | Top Color/Pattern |
|----------------------------------|----------------------|----------------------|-----------------|---------------------------|----------------------------|
| JBEAFB | 60 - 60" 72 - 72" | 20 - 20" 24 - 24" | REC - Rectangle | BL - Black SL - Silver | See above for HPL laminate |
| Example: J B E A F B + | 6 0 + | 2 0 + | R E C + | B L + | A S N T |

Ex: JBEAFB6020RECBLASNT – Jibe 60x20" Top in Asian Night with Black Base



| Model | Description | Size | List Price |
|---------------|-------------------------------|--------------------|------------|
| JBEAFB6020REC | Jibe A-Frame Bar Height Table | 60"W x 20"D x 42"H | 1,023.00 |
| JBEAFB6024REC | Jibe A-Frame Bar Height Table | 60"W x 24"D x 42"H | 1,136.00 |
| JBEAFB7220REC | Jibe A-Frame Bar Height Table | 72"W x 20"D x 42"H | 1,213.00 |
| JBEAFB7224REC | Jibe A-Frame Bar Height Table | 72"W x 24"D x 42"H | 1,349.00 |

Konverg Top & Base Options

Maple Top, Blue Base (MPIBU)



Top



Base

Walnut Top, Green Base (WLGN)



Top



Base

Walnut Top, White Base (WLWH)



Top



Base



| Parent # | Description | Color | Model # | List Price |
|---|---|--|--|------------|
| KVGCOF30RND  | Konverg Coffee Table Overall : 30"W x 30"D x 16"H | Maple Top, Blue Base Walnut Top, Green Base Walnut Top, White Base | KVGCOF30RNDMPIBU KVGCOF30RNDWLGN KVGCOF30RNDWLWH | 750.00 |



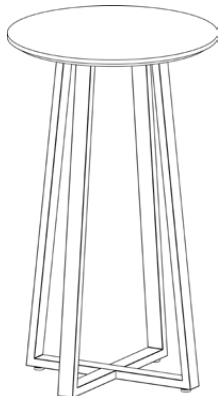

| Parent # | Description | Color | Model # | List Price |
|---|--|--|--|------------|
| KVGEND22RND  | Konverg End Table Overall : 22"W x 22"D x 25"H | Maple Top, Blue Base Walnut Top, Green Base Walnut Top, White Base | KVGEND22RNDMPIBU KVGEND22RNDWLGN KVGEND22RNDWLWH | 675.00 |

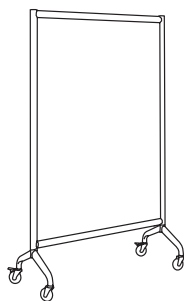

| Parent # | Description | Color | Model # | List Price |
|---|--|--|--|------------|
| KVGBAR24RND  | Konverg Bar Table Overall : 24"W x 24"D x 41"H | Maple Top, Blue Base Walnut Top, Green Base Walnut Top, White Base | KVGBAR24RNDMPIBU KVGBAR24RNDWLGN KVGBAR24RNDWLWH | 900.00 |

IDYA WHITEBOARD COLLECTION



| Parent # | Description | Model # | List Price |
|-----------|---|-------------|------------|
| IDYWB3654 | Mobile Whiteboard Screen Overall: 36"W x 16"D x 54"H | IDYWB3654SL | 2,400.00 |
| IDYWB4254 | Mobile Whiteboard Screen Overall: 42"W x 16"D x 54"H | IDYWB4254SL | 2,500.00 |
| IDYWB3666 | Mobile Whiteboard Screen Overall: 36"W x 16"D x 66"H | IDYWB3666SL | 2,600.00 |
| IDYWB4266 | Mobile Whiteboard Screen Overall: 42"W x 16"D x 66"H | IDYWB4266SL | 2,700.00 |
| IDYERAGR | Screen Eraser Tray  | IDYERAGR | 50.00 |



LIGHTING

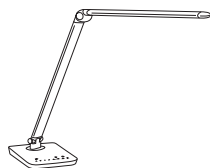

| Parent # | Description | Color | Model # | List Price |
|----------|--|--------|-----------|------------|
| LULDLP | Lulli LED Desk Lamp  | Black | LULDLPBL | 300.00 |
| | 5"W x 16"D x 16.75"H | Silver | LULDLP SL | |
| | | White | LULDLPWH | |

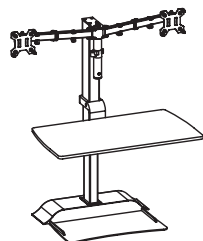

| Parent # | Description | Color | Model # | List Price |
|----------|--|-------|----------|------------|
| ACCSSE | Accend Desktop Monitor Lift  | White | ACCSSEWH | 1,900.00 |
| | Dual Monitor Arms Overall: 27.75"W x 22"D x 18.5-37.25"H | | | |

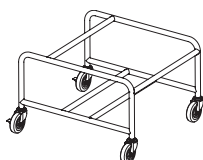

| Parent # | Description | Model # | List Price |
|----------|--|----------|------------|
| CRTSLD | Sled Base Stacking Chair Cart  | CRTSLDSL | 245.00 |
| | Can stack 20 units depending on the chair Overall: 23.5"W x 27.5"D x 17"H | | |

Color Options



Onyx
(ONYX)



Graphite
(GRPT)



Granite
(GRNT)



Midnight Blue
(MNBL)



Cream
(CRME)

- All models have Blade Feet: 2.25"W x 18"D x .375"H
- Solid, Matrix and Chain Patterns are PET Material

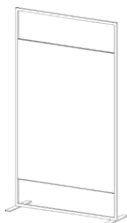

| Parent # | Description | Dimensions | Model # | List Price |
|----------|---------------|--|-----------|------------|
| FSDSD | Solid Surface | Frame Size: 36"W x 72"H, Screen Size: 60"H | FSDSD3672 | 4,525.00 |
| | | Frame Size: 48"W x 72"H, Screen Size: 60"H | FSDSD4872 | 4,795.00 |
| | | Frame Size: 36"W x 84"H, Screen Size: 60"H | FSDSD3684 | 4,835.00 |
| | | Frame Size: 48"W x 84"H, Screen Size: 60"H | FSDSD4884 | 5,110.00 |

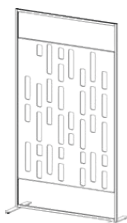

| Parent # | Description | Dimensions | Model # | List Price |
|----------|----------------|--|-----------|------------|
| FSDMX | Matrix Pattern | Frame Size: 36"W x 72"H, Screen Size: 60"H | FSDMX3672 | 5,288.00 |
| | | Frame Size: 48"W x 72"H, Screen Size: 60"H | FSDMX4872 | 5,526.00 |
| | | Frame Size: 36"W x 84"H, Screen Size: 60"H | FSDMX3684 | 5,831.00 |
| | | Frame Size: 48"W x 84"H, Screen Size: 60"H | FSDMX4884 | 6,069.00 |

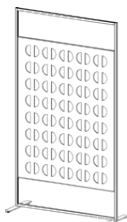

| Parent # | Description | Dimensions | Model # | List Price |
|----------|---------------|--|-----------|------------|
| FSDCN | Chain Pattern | Frame Size: 36"W x 72"H, Screen Size: 60"H | FSDCN3672 | 5,288.00 |
| | | Frame Size: 48"W x 72"H, Screen Size: 60"H | FSDCN4872 | 5,526.00 |
| | | Frame Size: 36"W x 84"H, Screen Size: 60"H | FSDCN3684 | 5,831.00 |
| | | Frame Size: 48"W x 84"H, Screen Size: 60"H | FSDCN4884 | 6,069.00 |

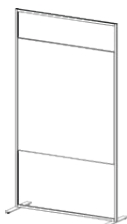

| Parent # | Description | Dimensions | Model # | List Price |
|----------|---------------------|--|-----------|------------|
| FSDMB | Markerboard Surface | Frame Size: 36"W x 72"H, Screen Size: 48"H | FSDMB3672 | 5,387.00 |
| | | Frame Size: 48"W x 72"H, Screen Size: 48"H | FSDMB4872 | 5,523.00 |
| | | Frame Size: 36"W x 84"H, Screen Size: 48"H | FSDMB3684 | 5,856.00 |
| | | Frame Size: 48"W x 84"H, Screen Size: 48"H | FSDMB4884 | 5,992.00 |

| Model | Width | Height | Panel Color |
|---|-----------------------|-----------------------|---|
| FSDSD - Solid | 36 | 72 | ONYX - Onyx |
| FSDMX - Matrix Pattern | 48 | 84 | GRPT - Graphite |
| FSDCH - Chain Pattern | | | GRNT - Granite |
| | | | MNBL - Midnight Blue |
| | | | CRME - Cream |
| FSDMB - Marker Board | | | DRYE - Markerboard Only |
| Example: | | | |
| <u> </u> <u> </u> <u> </u> <u> </u> <u> </u> <u> </u> <u> </u> + | <u> </u> <u> </u> + | <u> </u> <u> </u> + | <u> </u> <u> </u> <u> </u> <u> </u> |

Color Options



Granite (GRNT)



Graphite (GRPT)

- PET Material
- Handle Cutout 2" Radius
- Feet: 4" W x 2" H
- Available in Granite and Graphite

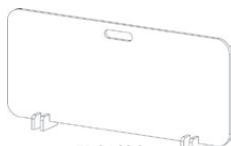

FDS1636



FDS1648



FDS1660

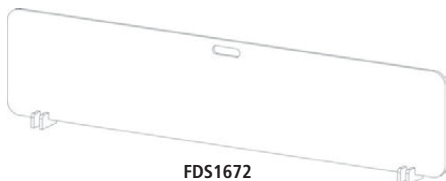

FDS1672

| Model | Size | List Price |
|---------|--------------------------|------------|
| FDS1636 | Screen Size: 36"W x 16"H | 70.00 |
| FDS1648 | Screen Size: 48"W x 16"H | 80.00 |
| FDS1660 | Screen Size: 60"W x 16"H | 100.00 |
| FDS1672 | Screen Size: 72"W x 16"H | 110.00 |

| Model | Color |
|--|-------------------------------|
| FDS1636 - Desk Screen 36" FDS1648 - Desk Screen 48" FDS1660 - Desk Screen 60" FDS1672 - Desk Screen 72" | GRNT-Granite GRPT-Graphite |
| Example: F D S 1 5 3 6 + | G R N T |

Laminate + Matching Edge Color Option



Base Options



- 36" lockers available with two 18" doors with internal dividing shelf
- Keyed (random - master key available) or Digital Locks (revolving code)
- Individual locker modules ship fully assembled
- Concealed adjustable door hinges
- Work surfaces are constructed with 1.125" particle board with HPL and 3mm PVC edge banding
- 4 leveling glides for easy alignment (per locker)
- Ganging hardware included for front to back, side to side, and top to bottom connection
- Optional toe-kick for use with UNYLOCFS18 & UNYLOCFS36
- All steel is finished with powder coat paint (white or textured black)

Laminate Edge Type

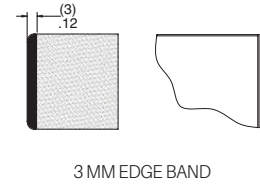

Fabric Options

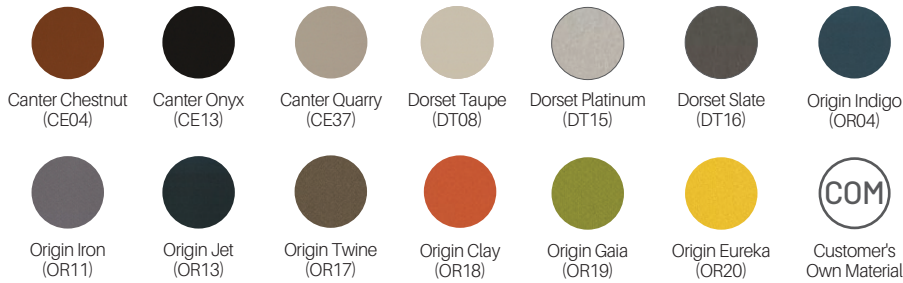

FREE-STANDING LOCKERS

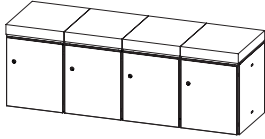

| Parent # | Description | Model # | List Price |
|--|--|-----------------|------------|
| UNY01  | Bench with Cushion Locker Height: 18.5" Seat Size: 60"W x 18"D Overall Size: 60"W x 18"D x 20.5"H | UNY01 | 4,612.00 |
| Option | | Upcharge | |
| Door Material Steel or Laminate (HPL) | | N/C | |
| Lock Type | | | |
| Keyed Lock | | N/C | |
| Digital Lock - DL (Price is Per Lock) | | 106.00 | |
| Metal Color | | | |
| White Powder Coat | | N/C | |
| Black Textured Powder Coat | | N/C | |

| Parent | Cabinet Color | Door Material | Door Color | Lock Type | Fabric |
|----------------------------------|-----------------------------------|-------------------------------|---|--------------------------------------|--------------------------------|
| UNY01 | WH - White BL - Black Textured | STE - Steel LAM - Laminate | See page 29 for laminate with matching edgeband choices | KL - Keyed Lock DL - Digital Lock | See page 29 for fabric options |
| Example: <u>UNY01+</u> | <u>BL+</u> | <u>LAM+</u> | <u>CLWN+</u> | <u>DL+</u> | <u>OR11</u> |

STAND-ALONE LOCKER OPTIONS

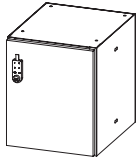

| Parent # | Description | Model # | List Price |
|---|---|------------|------------|
| UNYLOCFS18  | 18" Single Locker Overall Size: 15"W x 18"D x 18.5"H | UNYLOCFS18 | 880.00 |

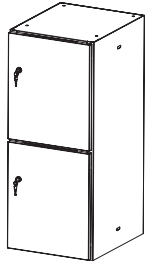

| Parent # | Description | Model # | List Price |
|---|--|------------|------------|
| UNYLOCFS36  | 36" Single Locker Overall Size: 15"W x 18"D x 36.5"H Number of Doors for 36" Lockers: Double Door-DD | UNYLOCFS36 | 1,639.00 |

| Option | Upcharge |
|---------------------------------------|----------|
| Door Material Steel | N/C |
| Lock Type | |
| Keyed Lock | N/C |
| Digital Lock - DL (Price is Per Lock) | 106.00 |
| Metal Color | |
| White Powder Coat | N/C |
| Black Textured Powder Coat | N/C |

| Parent | Number of Doors* | Cabinet Color | Door Material | Door Color | Lock Type |
|---------------------------------------|----------------------------------|-----------------------------------|-------------------------------|---|--------------------------------------|
| UNYLOCFS18 UNYLOCFS36 | DD-Double Door SD-Single Door | WH - White BL - Black Textured | STE - Steel LAM - Laminate | See page 29 for laminate with matching edgeband choices | KL - Keyed Lock DL - Digital Lock |
| Example: <u>UNYLOCFS36+</u> | <u>DD+</u> | <u>BL+</u> | <u>LAM+</u> | <u>DSWT+</u> | <u>KD</u> |

*Single Door (SD) only available on UNYLOCFS36

Unyon Storage Collection

UNYON

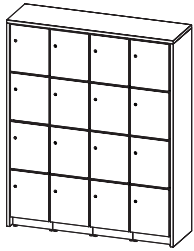

| Parent # | Description | Model # | List Price |
|-----------|--|-----------------|------------|
| UNY06 | Locker Wall Overall Size: Overall Size: 62.5"W x 18.5"D x 77.5"H Number of Doors for 36" Lockers: Double Door-DD | UNY06 | 15,687.00 |
| | Option | Upcharge | |
| | Door Material Steel | N/C | |
| | Lock Type | | |
| | Keyed Lock | N/C | |
| | Digital Lock - DL (Price is Per Lock) | 106.00 | |
| | Metal Color | | |
| | White Powder Coat | N/C | |
| | Black Textured Powder Coat | N/C | |

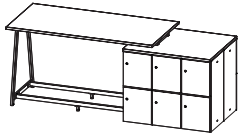

| Parent # | Description | Model # | List Price |
|-----------|---|---------|------------|
| UNY08 | A-Frame w/Riser (Long) Counter Size: 75"W x 37"D Locker Surface Height: 37.75"H Overall Size: 105"W x 37"D x 41.5"H Number of Doors for 36" Lockers: Double Door-DD | UNY08 | 15,244.00 |

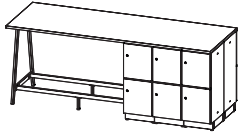

| Parent # | Description | Model # | List Price |
|-----------|---|---------|------------|
| UNY10 | A-Frame Bistro (Long) Counter Size: 105"W x 37"D Overall Size: 105"W x 37"D x 41.5"H Number of Doors for 36" Lockers: Double Door-DD | UNY10 | 15,103.00 |

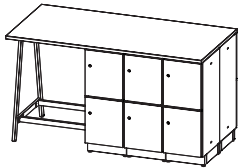

| Parent # | Description | Model # | List Price |
|-----------|--|---------|------------|
| UNY11 | A-Frame Bistro (Short) Counter Size: 75"W x 37"D Overall Size: 75"W x 37"D x 41.5"H Number of Doors for 36" Lockers: Double Door-DD | UNY11 | 13,415.00 |

| Option | Upcharge |
|---------------------------------------|----------|
| Door Material Steel | N/C |
| Lock Type | |
| Keyed Lock | N/C |
| Digital Lock - DL (Price is Per Lock) | 106.00 |
| Metal Color | |
| White Powder Coat | N/C |
| Black Textured Powder Coat | N/C |

| Parent | Base Color | Worksurface and Waterfall Color (HPL) | Number of Doors | Door Material | Door Color (HPL only) | Lock Type |
|--|-----------------------------------|---|--------------------------------------|-------------------------------|---|--------------------------------------|
| UYN06 UYN08 UYN10 UYN11 | WH - White BL - Black Textured | See page 29 for laminate with matching edgeband choices | DD - Double Door SD - Single Door | STE - Steel LAM - Laminate | See page 29 for laminate with matching edgeband choices *for Steel Door (STE), leave blank | KL - Keyed Lock DL - Digital Lock |
| Example: | | | | | | |
| <u>U</u> <u>Y</u> <u>N</u> <u>0</u> <u>6</u> + | <u>B</u> <u>L</u> + | <u>O</u> <u>R</u> <u>1</u> <u>8</u> + | <u>D</u> <u>D</u> + | <u>L</u> <u>A</u> <u>M</u> + | <u>O</u> <u>R</u> <u>1</u> <u>8</u> + | <u>D</u> <u>L</u> |

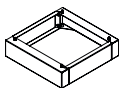

| Parent # | Description | Color | Model # | List Price |
|------------|--|-------------------------|----------------------|------------|
| UNYTKC | Toe-Kick Option for UNYLOCFS18 & UNYLOCFS36 Overall Size: 15"W x 15"D x 3.625"H | Black Textured White | UNYTKCBL UNYTKCWH | 132.00 |



| Description | Material | Model # | List Price |
|------------------|--|----------------------|------------|
| Replacement Keys | Replacement Key 201-300* 920000462 Master Key | 201-300 920000462 | 39.00 |

*When requesting a replacement key the lock/key number, located on the face of the lock, is required.

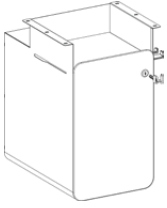

| Parent # | Description | Color | Model # | List Price |
|----------|---|--|----------------|------------|
| VYBLOCSU | Vybe Under Mount Desk Storage 14.4"W x 15.9"D x 19.4"H | Granite grey felt door on white metal locker | VYBLOCSUGRNTWH | 430.00 |
| | | Graphite felt door on black metal locker | VYBLOCSUGRPTBL | |

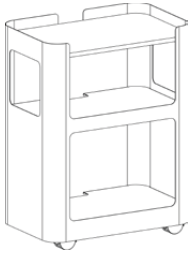

| Parent # | Description | Color | Model # | List Price |
|----------|--|-----------------------|-------------|------------|
| MOBCART | Mobe Open Shelf Mobile Cabinet 18.1"W x 11.4"D x 23.9"H | White with Walnut top | MOBCARTWLWH | 450.00 |

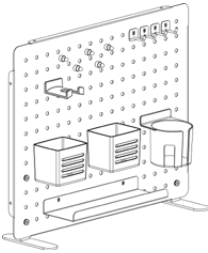

| Parent # | Description | Color | Model # | List Price |
|-----------|---|-------|-------------|------------|
| FRSVERTPB | Desktop Pegboard 20.5"W x 6.2"D x 16.9"H | White | FRSVERTPBWH | 150.00 |
| | | Black | FRSVERTPBBL | |



| Parent # | Description | Color | Model # | List Price |
|----------|--|----------------------|--------------|------------|
| ATDVDRMO | Atytude Trolley Vertical Drawers 35.4"W x 15.8"D x 27.6"H | White with White top | ATDVDRMOWHWH | 1,600.00 |



| Parent # | Description | Color | Model # | List Price |
|----------|--|----------------------|--------------|------------|
| ATDHDRMO | Atytude Trolley Horizontal Drawers 35.4"W x 15.8"D x 27.6"H | White with White top | ATDHDRMOWHWH | 1,600.00 |

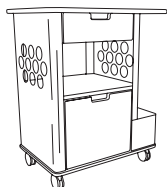

| Parent # | Description | Color | Model # | List Price |
|----------|--|-----------------------------|----------|------------|
| SPHRSC | Sphyr Rolling Storage Cart Overall Size: 28"W x 20"D x 33.5"H Work Surface: 28"W x 20"D Slide-Out Drawer 1: 15.75"W x 15.75"D x 5"H Slide-Out Drawer 2: 15.75"W x 15.75"D x 13.375"H Side Compartment: 5.5"W x 17.5"D x 7"H | Silver Frame with White Top | SPHRSCWH | 1,720.00 |





| Parent # | Description | Color | Model # | List Price |
|---|--|--------|----------|------------|
| STRHRD | Half Round Receptacle | White | STRHRDWH | 800.00 |
|  | 23 Gallon Capacity 10.25"W x 20.25"D x 32.25"H Includes: Can, Rim, Liner, and Sheet of 8 Black Decals (two of each option) Decals Included: COMPOST, MIXED RECYCLING, TRASH, WASTE | Silver | STRHRDSL | |



| Parent # | Description | Color | Model # | List Price |
|---|--|--------|----------|------------|
| STRREC | Rectangular Receptacle | White | STRRECWH | 800.00 |
|  | 29 Gallon Capacity 10.25"W x 20.25"D x 32.25"H Includes: Can, Rim, Liner, and Sheet of 8 Black Decals (two of each option) Decals Included: COMPOST, MIXED RECYCLING, TRASH, WASTE | Silver | STRRECSL | |

Introducing Modix, the innovative solution designed to revolutionize traditional panel and desking systems. Modix seamlessly bridges the gap between technical workstations and front office environments, offering a versatile platform that evolves to meet a variety of needs. Its flexible and adaptive design allows for the creation of customizable, attractive workstations that cater to diverse requirements. Featuring a range of relevant material options and practical features, Modix is the standout choice perfectly designed to meet the evolving needs of modern workspaces.

Laminate + Matching Edge Color Option

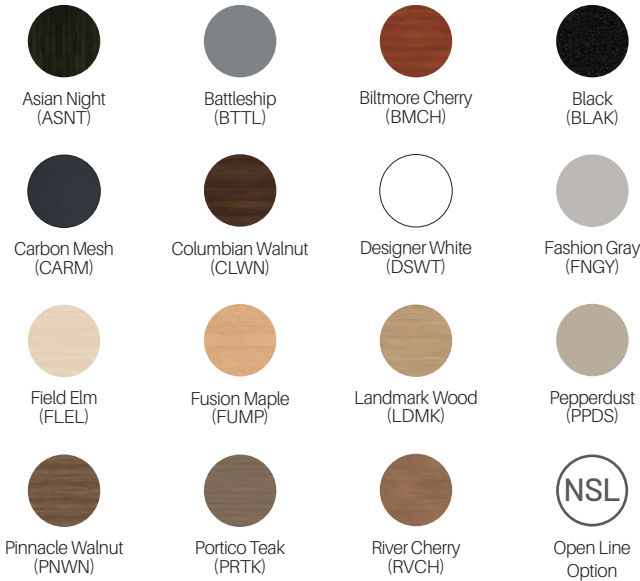

Powder Coat

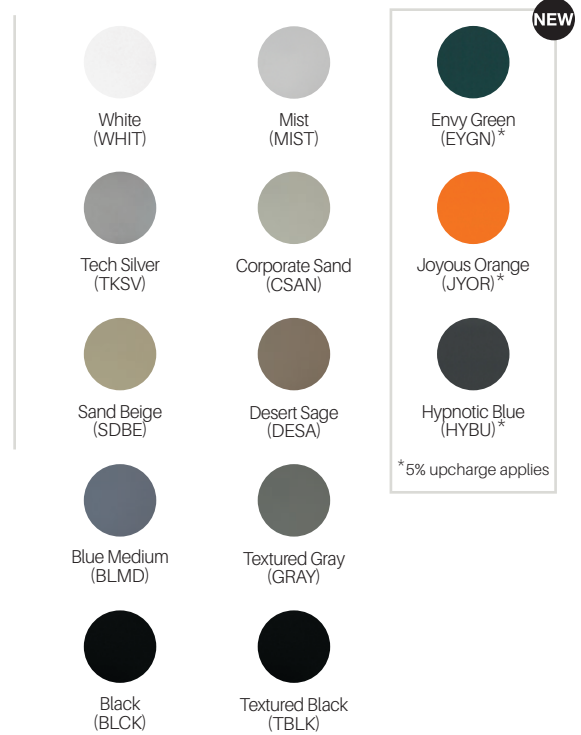

Cutout Options

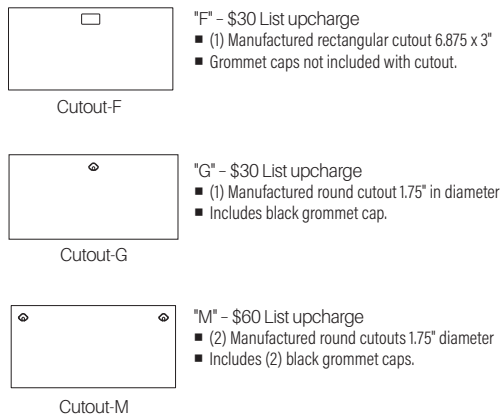

Laminate Edge Type

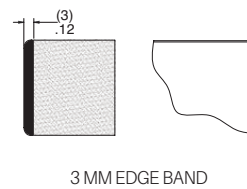

Note: All non-standard cutouts (other than above) will be reviewed to determine if the cutout does not interfere with the base, degrade table strength or cause imbalance. Contact specials@onsemblesolutions.com for quote request and drawing sign-off will be required before order is processed.

Modix Desks Features

Desks have 14" of travel range measuring 26" to 40"H from floor to the top of the work surface. Adjusts in 1" increments with threaded fasteners. Desks come standard with black hardware and black leveling glides; Optional caster kits are available for an additional \$375 list, featuring a set of 4 casters (Item CASKIT4). Casters will add 4" to overall desk height. Desks ship knocked down.

- Standard work surface options include:
HPL (High Pressure Laminate 1.125" thick) with 3mm edge band
- Grommet cutouts are available at an upcharge.
- Additional colors and work surface materials are available - upcharges, minimums and extended lead times may apply. Email specials@onsemblesolutions.com for quotation.
- Integrated cable management trough at the rear of each desk ensures that cords are neatly concealed and organized.
- The trough comes standard in a sleek black finish.

| Model | Type | Top Width | Top Depth | Top Shape | Glides/Casters | Base Color | Top Surface Material | Power Cut Out | Top Color/Pattern |
|----------------------------|------------|--|----------------|-----------------|-----------------------------|-------------|----------------------|---|-------------------|
| MDX - Modix | DSK - Desk | 36 42 48 54 60 66 72 | 24 30 36 | REC - Rectangle | GL - Glides CA - Casters | See page 35 | LAM - Laminate | N - None M - Left/Right Round Cutout | See page 35 |
| Example: M D X + | D S K + | 4 8 + | 2 4 + | R E C + | G L + | B L M D + | L A M + | M + | P P D S |
| Model Number | | | | | Configured Options | | | | |

Surface Cutout Options (Desks Only)



Cutout-M

- "M" - \$60 List upcharge
- (2) Manufactured round cutouts 1.75" diameter
 - Includes (2) black grommet caps.



36"W Rectangular Desk

| Model | Description | List Price |
|----------------|--|------------|
| MDXD SK3624REC | 36"W x 24"D x 26-40"H Adjustable Height Desk | 2,550.00 |
| MDXD SK3630REC | 36"W x 30"D x 26-40"H Adjustable Height Desk | 2,725.00 |
| MDXD SK3636REC | 36"W x 36"D x 26-40"H Adjustable Height Desk | 2,900.00 |

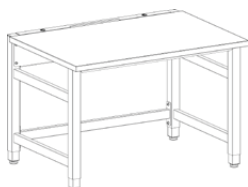

42"W Rectangular Desk

| Model | Description | List Price |
|----------------|--|------------|
| MDXD SK4224REC | 42"W x 24"D x 26-40"H Adjustable Height Desk | 2,625.00 |
| MDXD SK4230REC | 42"W x 30"D x 26-40"H Adjustable Height Desk | 2,800.00 |
| MDXD SK4236REC | 42"W x 36"D x 26-40"H Adjustable Height Desk | 2,975.00 |



48"W Rectangular Desk

| Model | Description | List Price |
|---------------|--|------------|
| MDXDSK4824REC | 48"W x 24"D x 26-40"H Adjustable Height Desk | 2,700.00 |
| MDXDSK4830REC | 48"W x 30"D x 26-40"H Adjustable Height Desk | 2,875.00 |
| MDXDSK4836REC | 48"W x 36"D x 26-40"H Adjustable Height Desk | 3,050.00 |

54"W Rectangular Desk

| Model | Description | List Price |
|---------------|--|------------|
| MDXDSK5424REC | 54"W x 24"D x 26-40"H Adjustable Height Desk | 2,775.00 |
| MDXDSK5430REC | 54"W x 30"D x 26-40"H Adjustable Height Desk | 2,950.00 |
| MDXDSK5436REC | 54"W x 36"D x 26-40"H Adjustable Height Desk | 3,125.00 |



60"W Rectangular Desk

| Model | Description | List Price |
|---------------|--|------------|
| MDXDSK6024REC | 60"W x 24"D x 26-40"H Adjustable Height Desk | 2,850.00 |
| MDXDSK6030REC | 60"W x 30"D x 26-40"H Adjustable Height Desk | 3,025.00 |
| MDXDSK6036REC | 60"W x 36"D x 26-40"H Adjustable Height Desk | 3,200.00 |

66"W Rectangular Desk

| Model | Description | List Price |
|---------------|--|------------|
| MDXDSK6624REC | 66"W x 24"D x 26-40"H Adjustable Height Desk | 2,925.00 |
| MDXDSK6630REC | 66"W x 30"D x 26-40"H Adjustable Height Desk | 3,100.00 |
| MDXDSK6636REC | 66"W x 36"D x 26-40"H Adjustable Height Desk | 3,275.00 |



72"W Rectangular Desk

| Model | Description | List Price |
|---------------|--|------------|
| MDXDSK7224REC | 72"W x 24"D x 26-40"H Adjustable Height Desk | 3,000.00 |
| MDXDSK7230REC | 72"W x 30"D x 26-40"H Adjustable Height Desk | 3,175.00 |
| MDXDSK7236REC | 72"W x 36"D x 26-40"H Adjustable Height Desk | 3,350.00 |

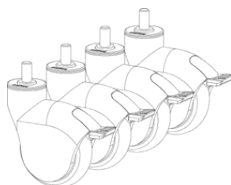

Caster Kit

| Model | Description | List Price |
|---------|-----------------------|------------|
| CASKIT4 | Caster Kit - Set of 4 | 375.00 |

Modix Return Features

Returns have 14" of travel range measuring 26" to 40"H from floor to the top of the work surface. Adjusts in 1" increments with threaded fasteners. Returns come standard with black hardware and black leveling glides; no caster option available. Non-handed. Returns ship knocked down.

- Standard work surface options include:
HPL (High Pressure Laminate 1.125" thick) with 3mm edge band.
- Additional colors and work surface materials are available - upcharges, minimums and extended lead times may apply. Email specials@onsemblesolutions.com for quotation.
- Returns feature a flexible design that allows for attachment to desks and tables at multiple increments, accommodating a wide range of space configurations and user needs.

| Model | Type | Top Width | Top Depth | Top Shape | Glides | Base Color | Top Surface Material | Power Cut Out | Top Color/Pattern |
|----------------------------|--------------|-----------|-----------|-----------------|---------------------------|-------------|----------------------|---------------|-------------------|
| MDX - Modix | RTN - Return | 36 42 | 18 24 | REC - Rectangle | GL - Glides | See page 35 | LAM - Laminate | N - None | See page 35 |
| Example: M D X + | R T N + | 3 6 + | 2 4 + | R E C + | G L + | B L C K + | L A M + | N + | P N W N |
| Model Number | | | | | Configured Options | | | | |

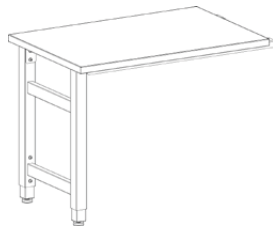

36"W Rectangular Return

| Model | Description | List Price |
|---------------|--|------------|
| MDXRTN3618REC | 36"W x 18"D x 26-40"H Adjustable Height Return | 1,275.00 |
| MDXRTN3624REC | 36"W x 24"D x 26-40"H Adjustable Height Return | 1,450.00 |

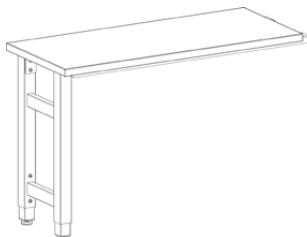

42"W Rectangular Return

| Model | Description | List Price |
|---------------|--|------------|
| MDXRTN4218REC | 42"W x 18"D x 26-40"H Adjustable Height Return | 1,350.00 |
| MDXRTN4224REC | 42"W x 24"D x 26-40"H Adjustable Height Return | 1,525.00 |

Modix Table Features

Tables have 14" of travel range measuring 26" to 40"H from floor to the top of the work surface. Adjusts in 1" increments with threaded fasteners. Tables come standard with black hardware and black leveling glides; Optional caster kits are available for an additional \$375 list, featuring a set of 4 casters (Item CASKIT4). Casters will add 4" to overall table height. Tables ship knocked down.

- Standard work surface options include:
 - HPL (High Pressure Laminate 1.125" thick) with 3mm edge band.
- Grommet and electrical cutouts are available at an upcharge.
- Additional colors and work surface materials are available - upcharges, minimums and extended lead times may apply. Email specials@onsemblesolutions.com for quotation.
- Optional lower shelves are available on 36", 42", and 48"D tables.
- All tables come equipped with built-in footrests. A single footrest is standard on 24" and 30"D tables, while dual footrests are standard on 36", 42", and 48"D tables.

| Model | Type | Top Width | Top Depth | Top Shape | Glides/Casters | Base Color | Top Surface Material | Power Cut Out | Top Color/Pattern |
|----------------------------|-------------|--|----------------------------|-----------------|-----------------------------|-------------|----------------------|---|-------------------|
| MDX - Modix | TBL - Table | 48 54 60 66 72 78 84 | 24 30 36 42 48 | REC - Rectangle | GL - Glides CA - Casters | See page 35 | LAM - Laminate | N - None F - Rectangle G - Center Round M - Left/Right Round | See page 35 |
| Example: M D X + | T B L + | 8 4 + | 4 8 + | R E C + | C A + | J Y O R + | L A M + | F + | D S W T |
| Model Number | | | | | Configured Options | | | | |

Surface Cutout Options (Tables Only)

24" & 30" D Tables



Cutout-F

- "F" - \$30 List upcharge
- (1) Manufactured rectangular cutout 6.875 x 3"
 - Grommet caps not included with cutout



Cutout-G

- "G" - \$30 List upcharge
- (1) Manufactured round cutout 1.75" in diameter
 - Includes black grommet cap



Cutout-M

- "M" - \$60 List upcharge
- (2) Manufactured round cutouts 1.75" diameter
 - Includes (2) black grommet caps

36", 42" & 48" D Tables



Cutout-F

- "F" - \$30 List upcharge
- (1) Manufactured rectangular cutout 6.875 x 3"
 - Grommet caps not included with cutout



Cutout-G

- "G" - \$30 List upcharge
- (1) Manufactured round cutout 1.75" in diameter
 - Includes black grommet cap



Cutout-M

- "M" - \$60 List upcharge
- (2) Manufactured round cutouts 1.75" diameter
 - Includes (2) black grommet caps

48"W Rectangular Table

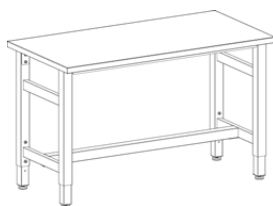

| Model | Description | List Price |
|---------------|---|------------|
| MDXTBL4824REC | 48"W x 24"D x 26-40"H Adjustable Height Table | 2,400.00 |
| MDXTBL4830REC | 48"W x 30"D x 26-40"H Adjustable Height Table | 2,575.00 |
| MDXTBL4836REC | 48"W x 36"D x 26-40"H Adjustable Height Table | 2,750.00 |
| MDXTBL4842REC | 48"W x 42"D x 26-40"H Adjustable Height Table | 2,925.00 |
| MDXTBL4848REC | 48"W x 48"D x 26-40"H Adjustable Height Table | 3,100.00 |

54"W Rectangular Table

| Model | Description | List Price |
|---------------|---|------------|
| MDXTBL5424REC | 54"W x 24"D x 26-40"H Adjustable Height Table | 2,475.00 |
| MDXTBL5430REC | 54"W x 30"D x 26-40"H Adjustable Height Table | 2,650.00 |
| MDXTBL5436REC | 54"W x 36"D x 26-40"H Adjustable Height Table | 2,825.00 |
| MDXTBL5442REC | 54"W x 42"D x 26-40"H Adjustable Height Table | 3,000.00 |
| MDXTBL5448REC | 54"W x 48"D x 26-40"H Adjustable Height Table | 3,175.00 |



60"W Rectangular Table

| Model | Description | List Price |
|---------------|---|------------|
| MDXTBL6024REC | 60"W x 24"D x 26-40"H Adjustable Height Table | 2,550.00 |
| MDXTBL6030REC | 60"W x 30"D x 26-40"H Adjustable Height Table | 2,725.00 |
| MDXTBL6036REC | 60"W x 36"D x 26-40"H Adjustable Height Table | 2,900.00 |
| MDXTBL6042REC | 60"W x 42"D x 26-40"H Adjustable Height Table | 3,075.00 |
| MDXTBL6048REC | 60"W x 48"D x 26-40"H Adjustable Height Table | 3,250.00 |

66"W Rectangular Table

| Model | Description | List Price |
|---------------|---|------------|
| MDXTBL6624REC | 66"W x 24"D x 26-40"H Adjustable Height Table | 2,625.00 |
| MDXTBL6630REC | 66"W x 30"D x 26-40"H Adjustable Height Table | 2,800.00 |
| MDXTBL6636REC | 66"W x 36"D x 26-40"H Adjustable Height Table | 2,975.00 |
| MDXTBL6642REC | 66"W x 42"D x 26-40"H Adjustable Height Table | 3,150.00 |
| MDXTBL6648REC | 66"W x 48"D x 26-40"H Adjustable Height Table | 3,325.00 |

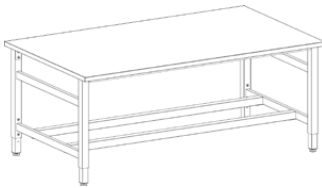

72"W Rectangular Table

| Model | Description | List Price |
|---------------|---|------------|
| MDXTBL7224REC | 72"W x 24"D x 26-40"H Adjustable Height Table | 2,700.00 |
| MDXTBL7230REC | 72"W x 30"D x 26-40"H Adjustable Height Table | 2,875.00 |
| MDXTBL7236REC | 72"W x 36"D x 26-40"H Adjustable Height Table | 3,050.00 |
| MDXTBL7242REC | 72"W x 42"D x 26-40"H Adjustable Height Table | 3,225.00 |
| MDXTBL7248REC | 72"W x 48"D x 26-40"H Adjustable Height Table | 3,400.00 |

78"W Rectangular Table

| Model | Description | List Price |
|---------------|---|------------|
| MDXTBL7824REC | 78"W x 24"D x 26-40"H Adjustable Height Table | 2,810.00 |
| MDXTBL7830REC | 78"W x 30"D x 26-40"H Adjustable Height Table | 2,985.00 |
| MDXTBL7836REC | 78"W x 36"D x 26-40"H Adjustable Height Table | 3,160.00 |
| MDXTBL7842REC | 78"W x 42"D x 26-40"H Adjustable Height Table | 3,335.00 |
| MDXTBL7848REC | 78"W x 48"D x 26-40"H Adjustable Height Table | 3,510.00 |

84"W Rectangular Table

| Model | Description | List Price |
|---------------|---|------------|
| MDXTBL8424REC | 84"W x 24"D x 26-40"H Adjustable Height Table | 2,885.00 |
| MDXTBL8430REC | 84"W x 30"D x 26-40"H Adjustable Height Table | 3,060.00 |
| MDXTBL8436REC | 84"W x 36"D x 26-40"H Adjustable Height Table | 3,235.00 |
| MDXTBL8442REC | 84"W x 42"D x 26-40"H Adjustable Height Table | 3,410.00 |
| MDXTBL8448REC | 84"W x 48"D x 26-40"H Adjustable Height Table | 3,585.00 |

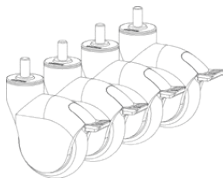

Caster Kit

| Model | Description | List Price |
|---------|-----------------------|------------|
| CASKIT4 | Caster Kit - Set of 4 | 375.00 |

Modix Table Shelf Feature

Flexible Shelf Options: A single shelf extends half the length of the table and can easily slide along the footbars, allowing for customizable placement. For those seeking full coverage, two shelves are available, providing versatile solutions tailored to your needs. Simply order two shelves for complete coverage.

- Powder coated steel lower shelves fit on 36", 42" and 48"D tables only.
- Shelves are non-handed.

| Model | Type | Width | Depth | Shape | Color |
|----------------------------|-------------------|--|-------|-----------------|---------------------------|
| MDX - Modix | TSH - Table Shelf | 22 25 28 31 34 37 40 | 19 | REC - Rectangle | See page 35 |
| Example: M D X + | T S H + | 3 7 + | 1 9 + | R E C + | B L C K |
| Model Number | | | | | Configured Options |

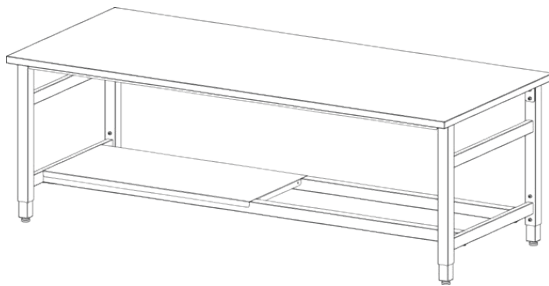

Half (1 Shelf)

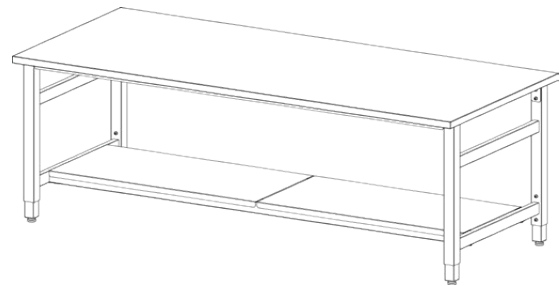

Full (2 Shelves)

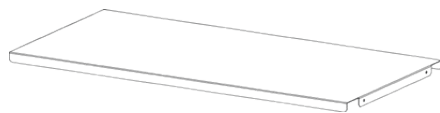

Table Shelf

| Model | Description | List Price |
|---------------|---|------------|
| MDXTSH2219REC | 22"W x 19"D Table Shelf (Fits 48"W x 36, 42, or 48"D Table) | 365.00 |
| MDXTSH2519REC | 25"W x 19"D Table Shelf (Fits 54"W x 36, 42, or 48"D Table) | 375.00 |
| MDXTSH2819REC | 28"W x 19"D Table Shelf (Fits 60"W x 36, 42, or 48"D Table) | 385.00 |
| MDXTSH3119REC | 31"W x 19"D Table Shelf (Fits 66"W x 36, 42, or 48"D Table) | 395.00 |
| MDXTSH3419REC | 34"W x 19"D Table Shelf (Fits 72"W x 36, 42, or 48"D Table) | 405.00 |
| MDXTSH3719REC | 37"W x 19"D Table Shelf (Fits 78"W x 36, 42, or 48"D Table) | 415.00 |
| MDXTSH4019REC | 40"W x 19"D Table Shelf (Fits 84"W x 36, 42, or 48"D Table) | 425.00 |

Modix Upper Frame Features

The upper frame design provides convenient support for hanging accessories above the work surface. Securely attached to the desk base, the fixed-height frame adjusts seamlessly with the desk, ensuring your essentials are always within reach.

- Each upper frame includes one stationary top bar and two configurable mounting bars, providing ample support for shelves, storage, and other accessories
- Upper frames are specifically designed to attach to Modix desks, with widths that correspond to the desk widths.
- Additional mounting bars can be purchased to expand your mounting options:
 37"H upper frame can accommodate up to 2 additional bars (6 total including top bar)
 25"H upper frame can accommodate up to 1 additional bar (4 total including top bar)
- The horizontal design allows users to easily relocate and slide accessories along the mounting bar, giving you the flexibility to customize your workstation to perfectly fit your needs.
- The upper frames are crafted from 14-gauge powder-coated steel, this construction ensures exceptional strength and durability.
- Mounting bars are crafted from durable 16-gauge powder-coated steel.

Upper Frame

| Model | Type | Width | Height | Color Options |
|---------------------|-------------------|--|--------------------|---------------|
| MDX - Modix | UFR - Upper Frame | 36 42 48 54 60 66 72 | 25 37 | See page 35 |
| Example: M D X + | U F R + | 4 2 + | 2 5 + | J Y O R |
| Model Number | | | Configured Options | |

Mounting Bar

| Model | Type | Width | Color Options |
|---------------------|--------------------------------|--|---------------|
| MDX - Modix | UMB - Upper Frame Mounting Bar | 36 42 48 54 60 66 72 | See page 35 |
| Example: M D X + | U M B + | 4 8 + | J Y O R |
| Model Number | | Configured Options | |



25"H Upper Frame

| Model | Description | List Price |
|------------|-------------------------|------------|
| MDXUFR3625 | 36"W x 25"H Upper Frame | 1,107.00 |
| MDXUFR4225 | 42"W x 25"H Upper Frame | 1,258.00 |
| MDXUFR4825 | 48"W x 25"H Upper Frame | 1,408.00 |
| MDXUFR5425 | 54"W x 25"H Upper Frame | 1,480.00 |
| MDXUFR6025 | 60"W x 25"H Upper Frame | 1,552.00 |
| MDXUFR6625 | 66"W x 25"H Upper Frame | 1,632.00 |
| MDXUFR7225 | 72"W x 25"H Upper Frame | 1,714.00 |

37"H Upper Frame

| Model | Description | List Price |
|------------|-------------------------|------------|
| MDXUFR3637 | 36"W x 37"H Upper Frame | 1,221.00 |
| MDXUFR4237 | 42"W x 37"H Upper Frame | 1,371.00 |
| MDXUFR4837 | 48"W x 37"H Upper Frame | 1,520.00 |
| MDXUFR5437 | 54"W x 37"H Upper Frame | 1,617.00 |
| MDXUFR6037 | 60"W x 37"H Upper Frame | 1,714.00 |
| MDXUFR6637 | 66"W x 37"H Upper Frame | 1,790.00 |
| MDXUFR7237 | 72"W x 37"H Upper Frame | 1,867.00 |

Additional Mounting Bars

| Model | Description | List Price |
|----------|-------------------------------|------------|
| MDXUMB36 | 36"W Upper Frame Mounting Bar | 540.00 |
| MDXUMB42 | 42"W Upper Frame Mounting Bar | 575.00 |
| MDXUMB48 | 48"W Upper Frame Mounting Bar | 610.00 |
| MDXUMB54 | 54"W Upper Frame Mounting Bar | 645.00 |
| MDXUMB60 | 60"W Upper Frame Mounting Bar | 680.00 |
| MDXUMB66 | 66"W Upper Frame Mounting Bar | 715.00 |
| MDXUMB72 | 72"W Upper Frame Mounting Bar | 750.00 |



Modix Upper Shelf Features

Upper shelves offer versatile storage solutions and are specifically designed to attach to the horizontal mounting bars of the upper frame structure. Depending on the shelf size, they can easily slide along the mounting bar or occupy the full length of the bar for maximum utilization.

- Available in durable high-pressure laminate (HPL) for added resilience.

| Model | Type | Width | Depth | Bracket Color | Shelf Material | Shelf Color/Pattern |
|--|------------------------------|--|---------------------|---------------------------------------|------------------------------|-------------------------------------|
| MDX - Modix | USF - Upper Shelf | 24 30 36 42 48 54 60 66 72 | 13 18 | See page 35 | LAM - Laminate | See page 35 |
| Example: <u>M</u> <u>D</u> <u>X</u> + | <u>U</u> <u>S</u> <u>F</u> + | <u>4</u> <u>2</u> + | <u>1</u> <u>3</u> + | <u>S</u> <u>D</u> <u>B</u> <u>E</u> + | <u>L</u> <u>A</u> <u>M</u> + | <u>L</u> <u>D</u> <u>M</u> <u>K</u> |
| Model Number | | | | Configured Options | | |



13"D Upper Shelves

| Model | Description | List Price |
|------------|-------------------------|------------|
| MDXUSF2413 | 24"W x 13"D Upper Shelf | 964.00 |
| MDXUSF3013 | 30"W x 13"D Upper Shelf | 998.00 |
| MDXUSF3613 | 36"W x 13"D Upper Shelf | 1,017.00 |
| MDXUSF4213 | 42"W x 13"D Upper Shelf | 1,043.00 |
| MDXUSF4813 | 48"W x 13"D Upper Shelf | 1,069.00 |
| MDXUSF5413 | 54"W x 13"D Upper Shelf | 1,132.00 |
| MDXUSF6013 | 60"W x 13"D Upper Shelf | 1,194.00 |
| MDXUSF6613 | 66"W x 13"D Upper Shelf | 1,253.00 |
| MDXUSF7213 | 72"W x 13"D Upper Shelf | 1,312.00 |

18"D Upper Shelves

| Model | Description | List Price |
|------------|-------------------------|------------|
| MDXUSF2418 | 24"W x 18"D Upper Shelf | 1,295.00 |
| MDXUSF3018 | 30"W x 18"D Upper Shelf | 1,337.00 |
| MDXUSF3618 | 36"W x 18"D Upper Shelf | 1,384.00 |
| MDXUSF4218 | 42"W x 18"D Upper Shelf | 1,405.00 |
| MDXUSF4818 | 48"W x 18"D Upper Shelf | 1,427.00 |
| MDXUSF5418 | 54"W x 18"D Upper Shelf | 1,507.00 |
| MDXUSF6018 | 60"W x 18"D Upper Shelf | 1,587.00 |
| MDXUSF6618 | 66"W x 18"D Upper Shelf | 1,668.00 |
| MDXUSF7218 | 72"W x 18"D Upper Shelf | 1,745.00 |

Modix Overhead Cabinet Features

Upper storage cabinets deliver flexible and efficient storage solutions, thoughtfully designed to securely attach to the horizontal mounting bars of the upper frame structure. Their innovative design allows for effortless sliding along the mounting bar, enabling seamless customization to suit individual preferences and optimize space.

- Available with robust laminate door fronts and a range of pull options to complement any aesthetic. Please refer to the chart below to select the preferred pull style.

| Model | Type 1 | Type 2 | Width | Depth | Height | Cabinet Paint Color | Door Material | Door Laminate Color | Lock Type | Pull Type |
|---------------------|------------------------|------------------|----------------|-------|--------|---------------------------|----------------|---------------------|--|--|
| MDX - Modix | OHC - Overhead Cabinet | DD - Double Door | 24 30 36 | 13 | 16 | See page 35 | LAM - Laminate | See page 35 | KD - Keyed Different KA - Keyed Alike NL - No Lock | 1B - Bar Black 1S - Bar Silver 2B - Loop Black 2S - Loop Silver 3B - Square Black 3S - Square Silver 4B - Arch Black 4S - Arch Silver |
| Example: M D X + | O H C + | D D + | 2 4 + | 1 3 + | 1 6 + | B L C K + | L A M + | P N W N + | N L + | 1 B |
| Model Number | | | | | | Configured Options | | | | |

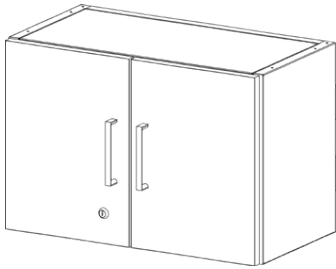

Overhead Storage Cabinet

| Model | Description | List Price |
|----------------|---|------------|
| MDXOHCDD241316 | 24"W x 13"D x 16"H Overhead Storage Cabinet | 1,531.00 |
| MDXOHCDD301316 | 30"W x 13"D x 16"H Overhead Storage Cabinet | 1,635.00 |
| MDXOHCDD361316 | 36"W x 13"D x 16"H Overhead Storage Cabinet | 1,725.00 |

| 1B - Bar Black 1S - Bar Silver | 2B - Loop Black 2S - Loop Silver | 3B - Square Black 3S - Square Silver | 4B - Arch Black 4S - Arch Silver |
|-----------------------------------|-------------------------------------|---|-------------------------------------|
| | | | |



PWR110V



PWRUSBAC

| Model | Description | Color | List Price |
|------------|---|-------|------------|
| PWR110VBL | Single Power Outlet | Black | 165.00 |
| PWR110VWH | Single Power Outlet | White | 165.00 |
| PWRUSBACBL | (1) USB-A/(1) USB-C Port | Black | 513.00 |
| PWRUSBACWH | (1) USB-A/(1) USB-C Port | White | 513.00 |
| PWREDGBL | NEW (2) 110V, (1) USB-A, (1) USB-C, Clamp Mount | Black | 644.00 |
| PWREDGWH | NEW (2) 110V, (1) USB-A, (1) USB-C, Clamp Mount | White | 644.00 |
| PWRISBL | NEW (2) 110V, (2) USB-A, (2) USB-C, Wall plug-In | Black | 1,018.00 |
| PWRISWH | NEW (2) 110V, (2) USB-A, (2) USB-C, Wall Plug-In | White | 1,018.00 |
| PWRISDCBL | NEW (2) 110V, (2) USB-A, (2) USB-C, Daisy Chain, 60" | Black | 1,041.00 |
| PWRISDCWH | NEW (2) 110V, (2) USB-A, (2) USB-C, Daisy Chain, 60" | White | 1,041.00 |
| PWRDCSL | NEW Daisy Chain Starter Link (Required to start chain) | | 1,122.00 |
| PWREXT | NEW Daisy Chain Extension, 12" | | 157.00 |

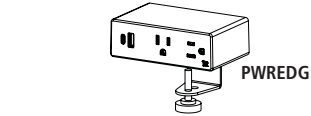

PWREDG

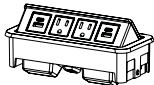

PWRIS

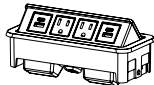

PWRISDC

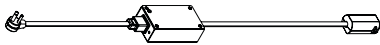

PWRDCSL **NEW** Daisy Chain Starter Link (Required to start chain) 1,122.00

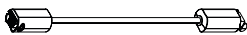

PWREXT **NEW** Daisy Chain Extension, 12" 157.00

For tables greater than 60" in length:

Connect up to 8 Daisy Chain Power/Data Modules (PWRISDC) plus 12" Extension(s) (PWREXT) to each Daisy Chain Power Infeed (PWRDCSL)

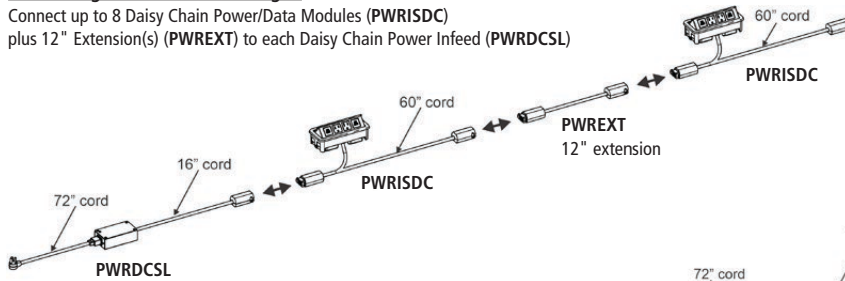

For tables 60" or shorter in length:

Connect up to 8 Daisy Chain Power/Data Modules (PWRISDC) to each Daisy Chain Power Infeed (PWRDCSL)

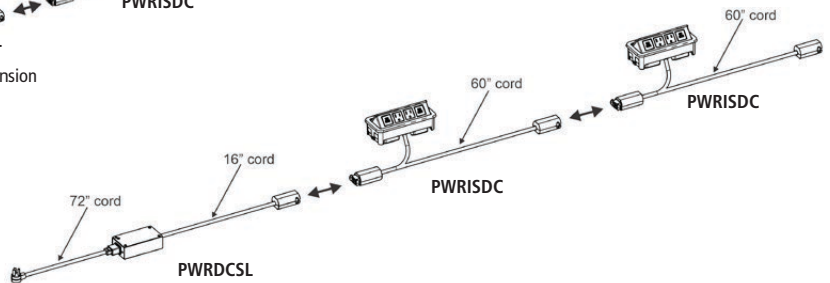

Index

| Model No. | Page | Model No. | Page | Model No. | Page | Model No. | Page |
|---------------|------|------------------|--------|----------------|------|------------------|------|
| ACCSEWH | 27 | AKDFXT7230REC | 21 | MDXDSK3630REC | 36 | MDXUFR3637 | 42 |
| ACZ4LGP | 12 | AKDXBB36RND | 23 | MDXDSK3636REC | 36 | MDXUFR4225 | 42 |
| ACZ4LGU | 12 | AKDXBB36SQR | 23 | MDXDSK4224REC | 36 | MDXUFR4237 | 42 |
| ACZBSTP | 14 | AKDXBB42RND | 23 | MDXDSK4230REC | 36 | MDXUFR4825 | 42 |
| ACZBSTU | 14 | AKDXBB42SQR | 23 | MDXDSK4236REC | 36 | MDXUFR4837 | 42 |
| ACZECHP | 14 | AKDXBS36RND | 23 | MDXDSK4824REC | 37 | MDXUFR5425 | 42 |
| ACZECHU | 14 | AKDXBS36SQR | 23 | MDXDSK4830REC | 37 | MDXUFR5437 | 42 |
| ACZGCHP | 13 | AKDXBS42RND | 23 | MDXDSK4836REC | 37 | MDXUFR6025 | 42 |
| ACZGCHU | 13 | AKDXBS42SQR | 23 | MDXDSK5424REC | 37 | MDXUFR6037 | 42 |
| ACZSLDP | 12 | ATDHDRMOWHWH | 33 | MDXDSK5430REC | 37 | MDXUFR6625 | 42 |
| ACZSLDU | 12 | ATDVMOWHWH | 33 | MDXDSK5436REC | 37 | MDXUFR6637 | 42 |
| ACZTCHP | 13 | CASKIT4 | 37, 40 | MDXDSK6624REC | 37 | MDXUFR7225 | 42 |
| ACZTCHU | 13 | COHTCHUBL | 18 | MDXDSK6630REC | 37 | MDXUFR7237 | 42 |
| ACZTSTP | 13 | COHTCHUBU | 18 | MDXDSK6636REC | 37 | MDXUMB36 | 42 |
| ACZTSTU | 13 | COHTCHUGR | 18 | MDXDSK7224REC | 37 | MDXUMB42 | 42 |
| AKDDBB36RND | 23 | CRTSLDSL | 27 | MDXDSK7230REC | 37 | MDXUMB48 | 42 |
| AKDDBB36SQR | 23 | DXDSK6024REC | 37 | MDXDSK7236REC | 37 | MDXUMB54 | 42 |
| AKDDBB42RND | 23 | DXDSK6030REC | 37 | MDXOHCDD241316 | 44 | MDXUMB60 | 42 |
| AKDDBB42SQR | 23 | DXDSK6036REC | 37 | MDXOHCDD301316 | 44 | MDXUMB66 | 42 |
| AKDDBS36RND | 23 | ECLGCHU | 17 | MDXOHCDD361316 | 44 | MDXUMB72 | 42 |
| AKDDBS36SQR | 23 | ECLMCHU | 17 | MDXRTN3618REC | 38 | MDXUSF2412 | 43 |
| AKDDBS42RND | 23 | ECLTCHU | 16 | MDXRTN3624REC | 38 | MDXUSF2418 | 43 |
| AKDDBS42SQR | 23 | ECLMSTU | 17 | MDXRTN4218REC | 38 | MDXUSF3012 | 43 |
| AKDFLP4818REC | 21 | FDS1636 | 29 | MDXRTN4224REC | 38 | MDXUSF3018 | 43 |
| AKDFLP4824REC | 21 | FDS1648 | 29 | MDXTBL 7830REC | 40 | MDXUSF3612 | 43 |
| AKDFLP4830REC | 21 | FDS1660 | 29 | MDXTBL4824REC | 39 | MDXUSF3618 | 43 |
| AKDFLP5418REC | 21 | FDS1672 | 29 | MDXTBL4830REC | 39 | MDXUSF4212 | 43 |
| AKDFLP5424REC | 21 | FRSVERTPBBL | 33 | MDXTBL4836REC | 39 | MDXUSF4218 | 43 |
| AKDFLP5430REC | 21 | FRSVERTPBWH | 33 | MDXTBL4842REC | 39 | MDXUSF4812 | 43 |
| AKDFLP6018REC | 21 | FSDCN3672 | 28 | MDXTBL4848REC | 39 | MDXUSF4818 | 43 |
| AKDFLP6024REC | 21 | FSDCN3684 | 28 | MDXTBL5424REC | 39 | MDXUSF5412 | 43 |
| AKDFLP6030REC | 21 | FSDCN4872 | 28 | MDXTBL5430REC | 39 | MDXUSF5418 | 43 |
| AKDFLP6618REC | 21 | FSDCN4884 | 28 | MDXTBL5436REC | 39 | MDXUSF6012 | 43 |
| AKDFLP6624REC | 21 | FSDMB3672 | 28 | MDXTBL5442REC | 39 | MDXUSF6018 | 43 |
| AKDFLP6630REC | 21 | FSDMB3684 | 28 | MDXTBL5448REC | 39 | MDXUSF6612 | 43 |
| AKDFLP7218REC | 21 | FSDMB4872 | 28 | MDXTBL6024REC | 40 | MDXUSF6618 | 43 |
| AKDFLP7224REC | 21 | FSDMB4884 | 28 | MDXTBL6030REC | 40 | MDXUSF7212 | 43 |
| AKDFLP7230REC | 21 | FSDMX3672 | 28 | MDXTBL6036REC | 40 | MDXUSF7218 | 43 |
| AKDFXP4818REC | 22 | FSDMX3684 | 28 | MDXTBL6042REC | 40 | MOBCARTWLWH | 33 |
| AKDFXP4824REC | 22 | FSDMX4872 | 28 | MDXTBL6048REC | 40 | MRJL1AU | 19 |
| AKDFXP4830REC | 22 | FSDMX4884 | 28 | MDXTBL630REC | 40 | MRJL1BU | 19 |
| AKDFXP5418REC | 22 | FSDSD3672 | 28 | MDXTBL648REC | 40 | MRJL1LU | 19 |
| AKDFXP5424REC | 22 | FSDSD3684 | 28 | MDXTBL6624REC | 40 | MRJL1OU | 19 |
| AKDFXP5430REC | 22 | FSDSD4872 | 28 | MDXTBL6636REC | 40 | MRJL1RU | 19 |
| AKDFXP6018REC | 22 | FSDSD4884 | 28 | MDXTBL6642REC | 40 | MRJL1TU | 19 |
| AKDFXP6024REC | 22 | IDYERAGR | 27 | MDXTBL7 230REC | 40 | Replacement Keys | 32 |
| AKDFXP6030REC | 22 | IDYWB3654SL | 27 | MDXTBL7 236REC | 40 | SPHRSCWH | 33 |
| AKDFXP6618REC | 22 | IDYWB3666SL | 27 | MDXTBL7 824REC | 40 | STRHRDSL | 34 |
| AKDFXP6624REC | 22 | IDYWB4254SL | 27 | MDXTBL7 836REC | 40 | STRHRDWH | 34 |
| AKDFXP6630REC | 22 | IDYWB4266SL | 27 | MDXTBL7 842REC | 40 | STRRECSL | 34 |
| AKDFXP7218REC | 22 | JBEAFB6020REC | 25 | MDXTBL7 848REC | 40 | STRRECWH | 34 |
| AKDFXP7224REC | 22 | JBEAFB6024REC | 25 | MDXTBL7224REC | 40 | UNY01 | 31 |
| AKDFXP7230REC | 22 | JBEAFB7220REC | 25 | MDXTBL7242REC | 40 | UNY06 | 32 |
| AKDFXT4818REC | 21 | JBEAFB7224REC | 25 | MDXTBL7248REC | 40 | UNY08 | 32 |
| AKDFXT4824REC | 21 | KVGBAR24RNDMPIBU | 26 | MDXTBL8424REC | 40 | UNY10 | 32 |
| AKDFXT4830REC | 21 | KVGBAR24RNDWLGN | 26 | MDXTBL8430REC | 40 | UNY11 | 32 |
| AKDFXT5418REC | 21 | KVGBAR24RNDWLWH | 26 | MDXTBL8436REC | 40 | UNYLOCFS18 | 31 |
| AKDFXT5424REC | 21 | KVGC0F30RNDMPIBU | 26 | MDXTBL8442REC | 40 | UNYLOCFS36 | 31 |
| AKDFXT5430REC | 21 | KVGC0F30RNDWLGN | 26 | MDXTBL8448REC | 40 | UNYTKC | 32 |
| AKDFXT6018REC | 21 | KVGC0F30RNDWLWH | 26 | MDXTSH2219REC | 41 | VYBLOCSUGRNTWH | 33 |
| AKDFXT6024REC | 21 | KVGEND22RNDMPIBU | 26 | MDXTSH2519REC | 41 | VYBLOCSUGRPTBL | 33 |
| AKDFXT6030REC | 21 | KVGEND22RNDWLGN | 26 | MDXTSH2819REC | 41 | WELPRUBL | 18 |
| AKDFXT6618REC | 21 | KVGEND22RNDWLWH | 26 | MDXTSH3119REC | 41 | WELPRSUBU | 18 |
| AKDFXT6624REC | 21 | LULDLPBL | 27 | MDXTSH3419REC | 41 | WELPRSUGN | 18 |
| AKDFXT6630REC | 21 | LULDLPBL | 27 | MDXTSH3719REC | 41 | WELPRSUGR | 18 |
| AKDFXT7218REC | 21 | LULDLPWH | 27 | MDXTSH4019REC | 41 | | |
| AKDFXT7224REC | 21 | MDXDSK3624REC | 36 | MDXUFR3625 | 42 | | |

