

on se mple le™



Table of Contents

General Information

Freight Policy.....	4	Warranty Statement	9
Customer's Own Material	5-6	Quality Statement.....	10
Open Line Laminate (OLL).....	7-8	Chair Features & Adjustments	11

Seating

Stack

Arcozi Four-Leg	12
Arcozi Sled	12
Arcozi Bistro-Height.....	14

Guest

Arcozi Guest.....	13
Enclude Guest	17

Task

Arcozi Task.....	13
Arcozi Classroom.....	14
Enclude Basic Task.....	16
Enclude Deluxe Task.....	16
Cohere	18

Conference

Enclude Conference	17
--------------------------	----

Stools

Arcozi Task Stool.....	13
Arcozi Bistro-Height.....	14
Enclude Multi-Purpose Stool	17
Welle.....	18

Lounge

Murj.....	19
-----------	----

Tables

Multi-Purpose

Akord	21
Jibe	25

Flip & Nest

Akord Flip	21
------------------	----

Conference

Akord Conference.....	23
-----------------------	----

Cafe

Akord	23
-------------	----

Bar & Bistro

Jibe	25
------------	----

Occasional

Konverg	26
---------------	----

Specialty

Unyon	30-32
Modix.....	35-44

Table Accessories

Cord Management	24
Desk Screen	24
Modesty Panel.....	24
Power.....	24

Workstations

Desks

Akord	22
Modix	35-45

Storage

Vybe	33
------------	----

Accessories

Modesty Panel	24
Accend Monitor Lift	27
Desk Screen	29
Peg Board	33

Storage

Personal

Atytude	33
Mobee	33
Sphyr	33
Vybe	33

Communal

Unyon	30-32
-------------	-------

Ancillary

Screens

Floor Screens	28
Desk Screens	29

Whiteboards

Idya	27
------------	----

Organization

Peg Board	33
-----------------	----

Lighting

Lulli	27
-------------	----

Power

ConnecTrac	24
Table	24

Ergonomics

Accend	27
--------------	----

Seating

Mobile Chair Cart	27
-------------------------	----

Waste & Recycling

Stream	34
--------------	----

Freight Policy

EFFECTIVE JANUARY 3, 2022

Prepaid on all orders of \$1,500 Net or more.

Orders less than \$1,500 Net:

LTL: \$150 Flat rate

Small Parcel: \$25 Flat rate

Orders containing both LTL and small parcel: \$150 flat rate

MINIMUM ORDERS

No minimum order requirement, however, all orders must be placed in full carton quantities.

Special routing request fees for LTL (Accessorial Charges):

- Call before Delivery - Included. Please specify at order entry.
- Lift Gate Assistance - \$125 for orders requiring a lift gate (no loading dock).
- Inside Delivery - \$50 for delivery to threshold only of first door.
 - Does not include put in place, un-carton, assembly, or trash removal.
 - Local restrictions may apply.
- Additional redelivery or storage charges may apply if special routing requests are not specified ahead of time and additional trips are required.
- Contact Customer Service at info@onsemblesolutions.com for a quote on Expedited Service (guaranteed date and time of delivery), or larger volume orders or special services requested over 2,000 lbs. Onsemble is not responsible for issues or costs arising from carrier transit delays, missed delivery appointments, etc.

Freight Damage

All shipments must be carefully inspected upon receipt by the assigned freight forwarder to ensure all items are in satisfactory condition before signing the bill of lading. If there is visible damage or shortage, it must be noted on the bill of lading. If not noted, we will be unable to file a claim with the carrier due to their policies. Visible damage or shortage must be reported within 24 hours of receipt of goods by the freight forwarder.

ORDERING INSTRUCTIONS

For inquiries regarding the specification of COM materials applied to Onsemble made to order seating solutions, contact (info@onsemblesolutions.com).

Step 1: Retrieve the necessary Onsemble made-to-order seating COM form found on page 6.

Step 2: Along with a copy of the COM form, send a 12"x12" material sample to:

909 4th St.

Milford IA, 51351.

Attention COM Receiving

Please include the model number and quantity of products required. This will allow for accurate yardage estimates.

Step 3: Upon approval of the material, please order the appropriate yardage and ship to:

909 4th St.

Milford IA, 51351.

Attention COM Receiving

Ensure the Onsemble purchase order number is included with the ship to address.

Step 4: Purchase orders will be acknowledged with production ship date.

THINGS TO KNOW

- All COM fabrics and vinyls must be approved by Onsemble and will not be scheduled for production until the entire yardage/square footage requirements have been received within the manufacturing facility.
- The COM approval process requires two business days to evaluate and process the 12"x12" material sample.
- Onsemble will not return excessive material. After 60 days from when the production order ships, any excess material will be recycled as part of our continued commitment to protecting the environment.
- Yardage requirements may vary based on several factors including:
Applied fabric direction, size, and geometry of the Onsemble product, and scale or print pattern. Yardage requirements will be conveyed to you upon approval of the 12"x12" sample. It is important to provide the product model number and units within the COM submission form. Yardage calculations are based on 54" wide materials.
- There are no minimum product unit requirements or pricing upcharges. Production lead-times vary by product. Standard warranty provisions apply.

Customer's Own Material - Approval Form

CUSTOMER & PRODUCT INFORMATION

Date		Customer Account Number	
Dealer Name		Purchase Order Number	
Dealer Contact		Onsemble Order Number, if available	
Street Address		Onsemble Product Model Number	
City, State, Zip Code		Onsemble Product Quantity (units)	
Phone Number			

TEXTILE INFORMATION

Mill		APPLICATION	
Fabric Color		Is there a desired top/bottom to the fabric? (YES/NO)	
Fabric Name/Number		Is the fabric a stripe or 2-color plaid? (YES/NO)	
Total Yardage Shipped			

TEXTILE ORIENTATION

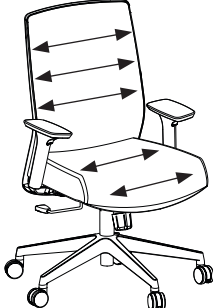
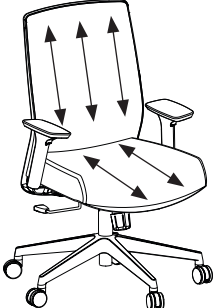
<p>Horizontal</p> <input type="checkbox"/>		<p>Vertical</p> <input type="checkbox"/>	
--	---	--	--

For customers requiring a specific laminate for tables, we offer open line laminate options.

ORDERING INSTRUCTIONS

- Step 1:** Retrieve the necessary OLL form for specifying and placing orders from the next page.
- Step 2:** Complete the form with as much detail as possible and submit it to info@onsemblesolutions.com.
- Step 3:** We will review your submission within 5 business days and respond promptly with final list pricing.
- Step 4:** Purchase orders will be acknowledged and the production ship date will be provided.

THINGS TO KNOW

- Open line laminate lead times typically range from 6-8 weeks, contingent on the HPL manufacturer and laminate availability.
- Onsemble will procure the specified and approved laminate in the required quantity of sheets to fulfill your project requirements.
- Due to standard laminate sheet sizes, laminates will be applied in a horizontal orientation unless otherwise specified.
- A \$75 net per table upcharge applies to Onsemble open line laminates.
- For open line laminate upcharges for 20 tables or more, and HPL laminates with special finishes or coatings, please contact specials@onsemblesolutions.com.
- If you have any inquiries regarding special open line laminates, please email info@onsemblesolutions.com.

Open Line Laminate (OLL) - Request Form

Return the completed form to info@onsemblesolutions.com

CUSTOMER & PROJECT INFORMATION

Date		Dealer Email	
Dealer Name		Customer Account No.	
Dealer Contact		Project Name	
Street Address		Install Date	
City, State, Zip Code		On-going Standards Program? Yes/No	
Phone Number			

PRODUCT INFORMATION

Onsemble Model/Series Name	
Onsemble Model/Series Number(s)	
Quantity Requested	

LAMINATE INFORMATION

Laminate Manufacturer	
Laminate Name	
Laminate Number	
Edge Band Name	
Edge Band Number	

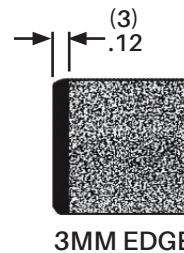

Edge Band Options

- Black (F756)
- Designer Whiter (F582)
- Ice Gray (F755)
- Warm Gray (F754)
- Taupe (F753)
- Silver (F791)
- Medium Brown (F849)
- Dark Brown (F850)
- Raven-Charcoal (F851)
- Brick (F858)
- Other:

ADDITIONAL PROJECT NOTES

1. Due to standard laminate sheet sizes, laminates will need to be applied in a horizontal orientation unless specified.
2. Onsemble open line laminates have a \$75 net per table up-charge.
3. Email specials@onsemblesolutions.com for open line laminate up-charges for 20 tables or more, and HPL laminates with special finishes.
4. For any questions about this form email info@onsemblesolutions.com.

Our warranty pledges excellence in the quality of our products. It helps protect our customer's investments and extends our continuing dedication to our customers after their initial investment.

LIMITED LIFETIME WARRANTY

Onsemble® warranty obligation: We pledge to repair or replace, at Onsemble's option, any Onsemble product or component that is defective in material or workmanship for as long as you, the original purchaser, own it. This warranty is subject to the provisions below.

LIABILITY LIMITATIONS

The following listed parts, components and supplies are covered under warranty in accordance with the below schedule following the product purchase date.

Ten Years: Seating controls and cylinders.

Five Years: Glides, casters, polymer-based components, seating upholstery (fabrics and leather), foam, armrests, chrome seating components, user-adjustable work surface mechanisms, laminates and other covering materials, drawer glides, electrical components, cabinets or mobile systems, components that are either moving parts or controls (guides that are in contact with moving parts).

Three Years: Outdoor Products, electrical components and Dry Erase Surfaces.

WARRANTY SUBJECT TO EXCLUSIONS

Exclusions pertaining to this warranty are as follows but are not limited to:

- Normal wear and tear
- Product or product components utilized with the intent to rent or lease
- Freight damages: Onsemble is not liable for any product damages sustained during shipping or handling operations. Onsemble provides specific policies and requirements regarding shipping and handling, and reserves the right to review and address product distribution matters separately.
- Product negligence: A product is not considered defective due to misuse or improper installation. Onsemble products must be installed, used and maintained
- in accordance with product instructions and warnings.
- Alterations or attachments to the product that were not approved by Onsemble
- All COM Fabric is not covered under this warranty
- All corrugated products or components
- Use of non-multiple shift products for multiple shifts
- Products purchased through a discontinued products promotion/liquidation

Onsemble's warranty obligation is limited to normal use upon receipt of our products.

SEATING USAGE

Normal commercial usage for seating is defined as the equivalent of a single shift, forty (40) hour work week. To the extent that a seating product is used in a manner exceeding this, the applicable warranty period will be reduced in a pro-rata manner.

WARRANTY PROCEDURES

Please follow the warranty procedures described below:

1. Once a defect has been discovered, the original purchaser must contact Onsemble® immediately (within 30 days of defect detection), in writing, with the serial number(s) (if applicable), date code and model number from the product(s) in question.
2. Upon inspection of the product(s), Onsemble® will collect all relevant information necessary for review of the request.
3. Product replacement and replacement parts will be authorized by a Customer Care representative if acknowledged to be necessary under product warranty eligibility conditions.

SPECIFIC LIMITATIONS REGARDING COLOR VARIATIONS, FABRICS AND FINISHES

Natural products have varying grains and colors. Due to such natural variations occurring in materials such as wood and leather, these characteristics are not considered defects. Onsemble does not warrant the color-fastness or matching of colors, grains or textures of such materials. Materials supplied, selected or provided by the customer (COM) are not warranted.

Buyer is responsible for freight to and from factory on all warranty claims. Any description of the goods sold hereunder, including any reference to Buyer's specifications and any description in catalogs, circulars and other written or digital material published by Onsemble is for the sole purpose of identifying goods and shall not create an express or implied warranty that the goods shall conform to such description.

THERE ARE NO OTHER WARRANTIES, AND Onsemble DISCLAIMS ALL IMPLIED WARRANTIES INCLUDING WARRANTIES OF MERCHANTABILITY, FITNESS FOR A PARTICULAR PURPOSE AND FREEDOM FROM PATENT INFRINGEMENT. NO AGENT, EMPLOYEE OR REPRESENTATIVE OF Onsemble HAS ANY AUTHORITY TO BIND Onsemble TO ANY AFFIRMATION, REPRESENTATION OR WARRANTY EXCEPT AS STATED HEREIN.

Onsemble SHALL HAVE NO LIABILITY FOR INDIRECT, INCIDENTAL, CONSEQUENTIAL OR SPECIAL DAMAGES OF ANY KIND. THESE LIMITATIONS ARE AGREED ALLOCATIONS OF RISK. UNDER NO CIRCUMSTANCES SHALL Onsemble's LIABILITY WITH REGARD TO THE SALE OR USE OF THE PRODUCTS EXCEED THE PURCHASE PRICE PAID BY THE BUYER FOR THE PRODUCTS. TERMS AND CONDITIONS OF THIS WARRANTY ARE SUBJECT TO CHANGE WITHOUT NOTICE.

Note: Onsemble® does not require the customer to fill out a warranty registration card. Please keep all purchase documents for the product in event the warranty is needed. Contact our Customer Care team for any warranty assistance at info@onsembleproducts.com or (877) 835-2935.

STATEMENT OF QUALITY

At Onsemble®, we understand that quality extends beyond simple function, and we are committed to the highest level of satisfaction in the manufacture, sale, and support of our products. From concept to delivery, we integrate high levels of quality as our standard and work hard to impress our customers every day. We strive for continuous improvements in all areas of product and service by regarding our quality programs as an integral part of the company's improvement process. Onsemble's quality program works to provide products that meet or exceed the quality standards our customers expect. We aim to set high environmental and safety standards by offering a large collection of third-party tested products that meet standards set forth by BIFMA, UL, the State of California, and others.

PROP 65 WARNINGS

Products with this icon  are subject to California Proposition 65. Please visit the product detail page on our website for specific information.

ENVIRONMENTAL COMMITMENTS

Onsemble not only holds itself to strict environmental standards, but we also require suppliers to follow these standards as a total supply chain initiative. Suppliers play an important role in our longstanding commitment to perform operations in a manner consistent with sound health, safety, and environmental management practices. Because of this, suppliers are not only expected to comply with applicable health, safety and environmental laws and regulations, they are expected to seek continuous improvement within these realms.

Onsemble continues to become an environmentally conscious company with the intention to offer more products that our customers can feel good about, and responsible practices that encourage sustainability, helping us obtain a proud standing in our community and the planet.

OPERATIONS

Onsemble advocates continuous improvement in the realms of efficient recycling and/or disposal of waste materials and improving treatment and control of waste emissions affecting air, water, and soil. We also encourage the practice of waste reduction operations such as machine efficiency, raw material utilization, conservation of soil, air, water quality, biodiversity, wildlife and aquatic habitats, the practice of sustainable forest management policies where applicable, end-of-life treatment recommendations, raw material and recycled content regulation, and legal compliance with environmental legislation.

DESIGN

We reserve the right to make changes in design and material, as well as discontinuance of parts and units, when such action is deemed to be an improvement in design, function and/or construction.

THE FOLLOWING ICONS ARE USED THROUGHOUT THIS PUBLICATION:



Shippable by
Small Package Carrier



PROP 65 Warning



Meets ANSI/BIFMA
Standards



Seat Height Adjustment

Quick and easy adjustment regulates height of chair relative to the floor.



Seat Glide Mechanism

Seat cushion travels forward and back, then locks into position.



Weight Sensitive Mechanism

Adjusts seat and back angles by sensing the user's body weight and reclines accordingly.



Tilt Tension

Controls rate and ease with which chair reclines to different weight and strength of users.



Tilt Lock

Locks tilt function when chair is in upright position.



Asynchronous Control

Three levers modify:

1. Angle of back relative to seat
2. Tilt (free float or infinite locking within a fixed range)
3. Forward tilt (for keyboard intensive applications)



Integral Lumbar Support

Easily adjust to enhance comfort.

There are many features to consider when selecting the perfect chair to suit your needs. The following symbols will help you choose the features that are right for you. These symbols are used throughout this pricer to help quickly identify each chair's features. The descriptions of the features shown are meant to be general explanations. The actual functions of the features may vary slightly between chair series.

Arcozi Seating Collection

Poly Options

Back & Lower Back/Seat Color Options

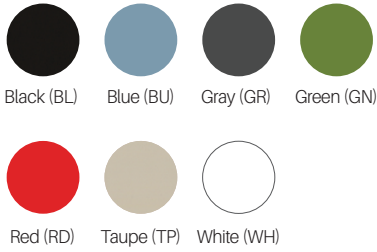

Shell Color Option Not Available. WH Only.



White (WH)

Frame Options



White Silver



Black
ACZTCH &
ACZTST only

Fabric Options

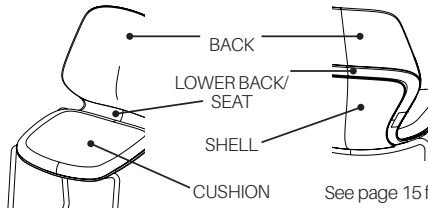
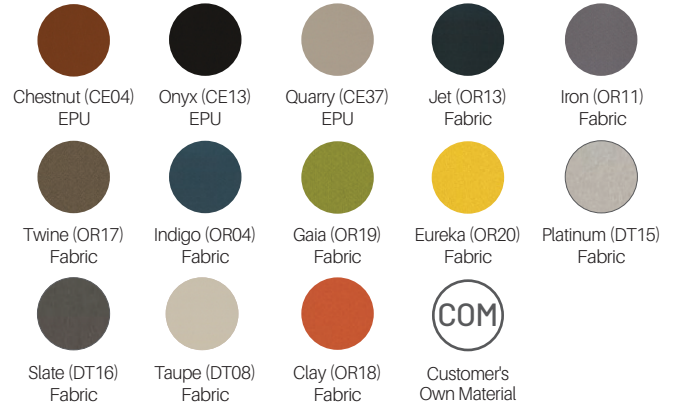

See page 15 for more chair details.

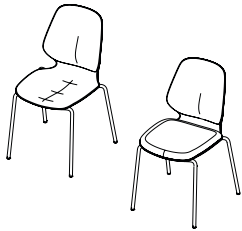

Parent #	Description	Color	Model #	List Price Ea.	List Carton Price	Quantity Per Carton
ACZ4LG	Arcozi 4 Leg Stack Chair Seat Height: 19" Chair Overall: 20.75"W x 22.25"D x 34.5"H	All Poly	ACZ4LGP	433.00	866.00	2
		Upholstered	ACZ4LGU	572.00	1,144.00	2

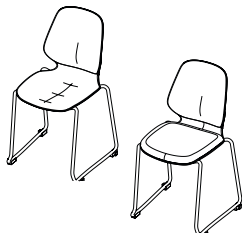

Parent #	Description	Color	Model #	List Price Ea.	List Carton Price	Quantity Per Carton
ACZSLD	Arcozi Sled Base Stack Chair Seat Height: 21" Chair Overall: 21.75"W x 21.75"D x 36.5"H	All Poly	ACZSLDP	451.00	902.00	2
		Upholstered	ACZSLDU	590.00	1,180.00	2

Model	Back Color		Seat Color		Upholstered Seat	Frame Color
ACZ4LGP - 4 Leg Stack Poly ACZ4LGU - 4 Leg Stack Uph. ACZSLDP - Sled Base Stack Poly ACZSLDU - Sled Base Stack Uph.	BL - Black BU - Blue GN - Green GR - Gray	RD - Red TP - Taupe WH - White	BL - Black BU - Blue GN - Green GR - Gray	RD - Red TP - Taupe WH - White	See above for Fabric Options *for All Poly, leave blank	SL-Silver WH-White
Example: ACZ4LGP +	BU +		BU +		OR18 +	SL

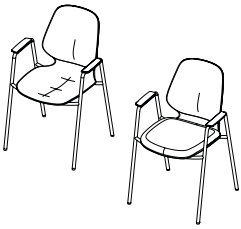

Parent #	Description	Material	Model #	List Price
ACZGCH	Arcozi Guest Chair Seat Height: 19" Chair Overall: 23.25"W x 22.25"D x 34.5"H	All Poly	ACZGCHP	572.00
		Upholstered	ACZGCHU	712.00

Model	Back Color	Seat Color	Upholstered Seat	Frame Color
ACZGCHP - Arcozi Guest Chair Poly ACZGCHU - Arcozi Guest Chair Uph.	BL - Black BU - Blue GN - Green GR - Gray	RD - Red TP - Taupe WH - White	BL - Black BU - Blue GN - Green GR - Gray	RD - Red TP - Taupe WH - White
			See page page 12 for Fabric Options *for All Poly, leave blank	SL-Silver WH-White
Example: A C Z G C H P +	B U +	B U +	O R 1 8 +	S L



Parent #	Description	Material	Model #	List Price
ACZTCH	Arcozi Task Chair Seat Height: 17-22" Chair Overall: 30.5"W x 30.5"D x 33-38"H	All Poly	ACZTCHP	746.00
		Upholstered	ACZTCHU	886.00

Option	Upcharge
Seat Poly Color	N/C
Back Poly Color	N/C
Add Arms	75.00
Standard Caster	N/C
Hard Floor Caster	N/C
Hard Floor Premium	65.00



Parent #	Description	Material	Model #	List Price
ACZTST	Arcozi Task Stool Seat Height: 22.25-32.25" Chair Overall: 30.5"W x 30.5"D x 38-48"H	All Poly	ACZTSTP	903.00
		Upholstered	ACZTSTU	1,042.00



Option	Upcharge
Seat Poly Color	N/C
Back Poly Color	N/C
Add Arms	75.00
Standard Caster	N/C
Hard Floor Caster	N/C
Hard Floor Premium	65.00

Model	Back Color	Seat Color	Upholstered Fabric	Arms	Casters
ACZTCHP - Task Chair Poly ACZTCHU - Task Chair Uph. ACZTSTP - Task Stool Poly ACZTSTU - Task Stool Uph	BL-Black BU-Blue GN-Green GR-Gray	RD-Red TP-Taupe WH-White	BL-Black BU-Blue GN-Green GR-Gray	RD-Red TP-Taupe WH-White	See page 12 for Fabric Options *for All Poly, leave blank
Example: A C Z T C H P +	B L +	B U +	O R 1 8 +	A L +	S T H F H F P

Arcozi Seating Collection

ARCOZI

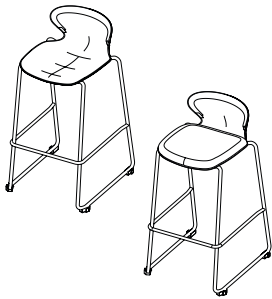

Parent #	Description	Color	Model #	List Price Ea.	List Carton Price	Quantity Per Carton
ACZBST	Arcozi Bar Height Stool	All Poly	ACZBSTP	729.00	1,458.00	2
	Seat Height: 33" Chair Overall: 21.5"W x 24"D x 40.75"H	Upholstered	ACZBSTU	868.00	1,736.00	2

Model	Seat Color	Upholstered Fabric	Frame Color
ACZBSTP - Arcozi Bar Height Chair Poly ACZBSTU - Arcozi Bar Height Chair Uph	BL-Black BU-Blue GN-Green GR-Gray	RD-Red TP-Taupe WH-White	SL-Silver WH-White
		See page 12 for Fabric Options *for All Poly, leave blank	
Example: <u>A</u> <u>C</u> <u>Z</u> <u>B</u> <u>S</u> <u>T</u> <u>P</u> +	<u>B</u> <u>U</u> +	<u>O</u> <u>R</u> <u>1</u> <u>8</u> +	<u>S</u> <u>L</u>

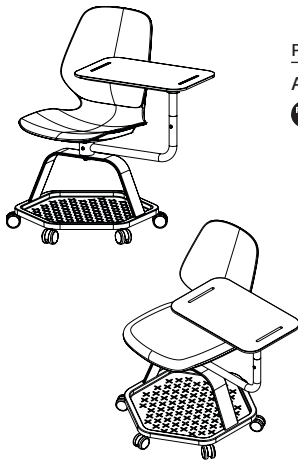

Parent #	Description	Color	Model #	List Price
ACZECH	Arcozi Education Chair Seat Height: 18.75" Chair Overall: 31.5"W x 26"D x 33.75"H	All Poly	ACZECHP	1,184.00
		Upholstered	ACZECHU	1,321.00

PROP 65

Accessory	Charge
Universal Tablet Arm	Subtract \$75 from price for No Tablet

Model	Back Color	Seat Color	Upholstered Fabric	Frame Color	Casters or Glides	Tablet Choice	Tablet Color	
ACZECHP - Arcozi Education Chair Poly ACZECHU - Arcozi Education Chair Uph.	BL-Black BU-Blue GN-Green GR-Gray	RD-Red TP-Taupe WH-White	BL-Black BU-Blue GN-Green GR-Gray	RD-Red TP-Taupe WH-White	SL-Silver WH-White	CA-Casters GL-Glides	WT-With Tablet NT-No Tablet	BL-Black WH-White
			See page 12 for Fabric Options *for All Poly, leave blank					
Example: <u>A</u> <u>C</u> <u>Z</u> <u>E</u> <u>C</u> <u>H</u> <u>P</u> +	<u>B</u> <u>L</u> +	<u>B</u> <u>U</u> +	<u>O</u> <u>R</u> <u>1</u> <u>8</u> +	<u>S</u> <u>L</u> +	<u>C</u> <u>A</u> +	<u>W</u> <u>T</u> +	<u>B</u> <u>L</u>	

- A. Back
- B. Lower Back Seat
- C. Shell
- D. Cushion (optional)
- E. Arm Pads
- F. Frame
- G. Glides
- H. Ganging Glides
- I. Arms
- J. Piston
- K. Cylinder
- L. Foot Ring
- M. 5-Star Base
- N. Casters
- O. Tablet
- P. Tablet Arm with Built-In Drink Holder
- Q. Base Shelf

Chair Details

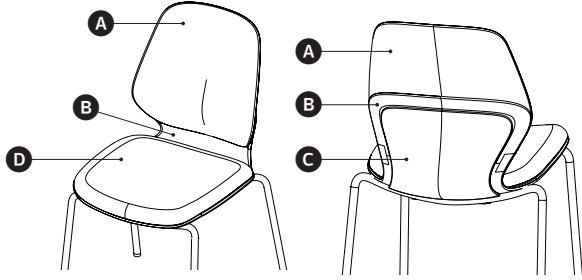

Stack Chair (4-Leg)

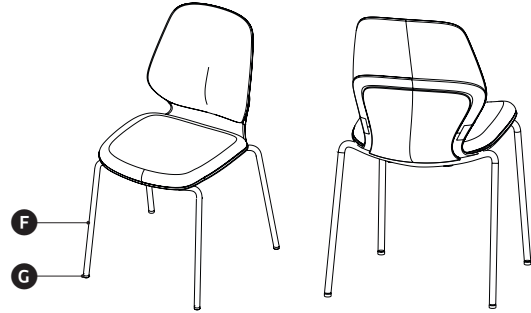

Stack Chair (Sled Base)

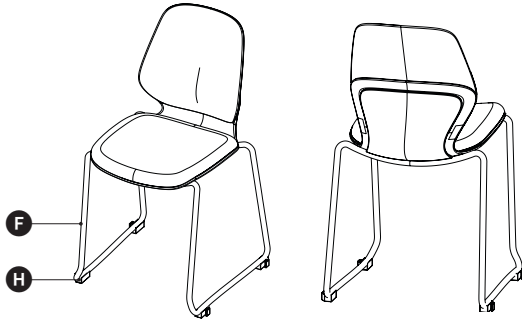

Guest Chair

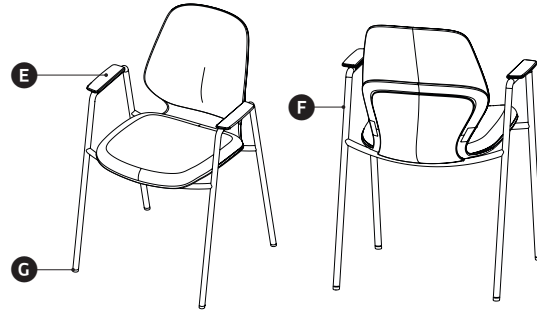

Bistro Chair

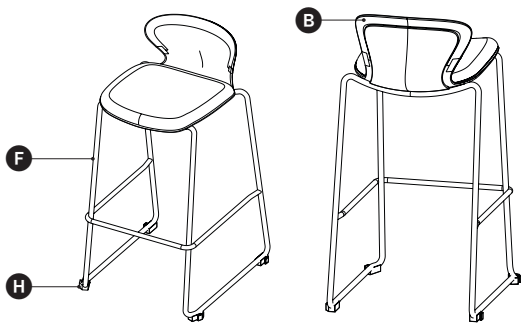

Task Chair

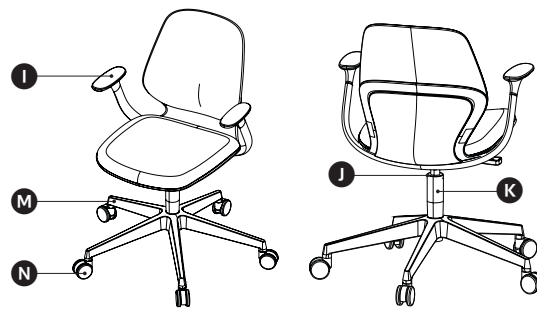

Extended-Height Chair



Education Chair

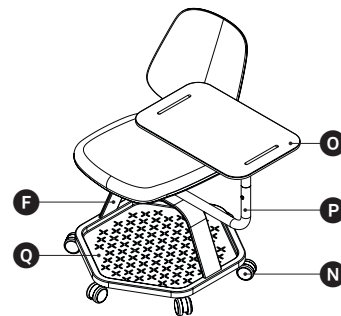

Enclude Seating Collection

ENCLUDE

Mesh Options

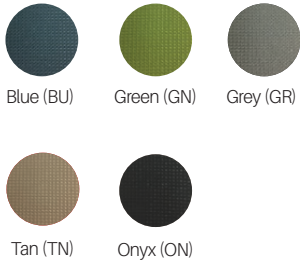

Fabric Options

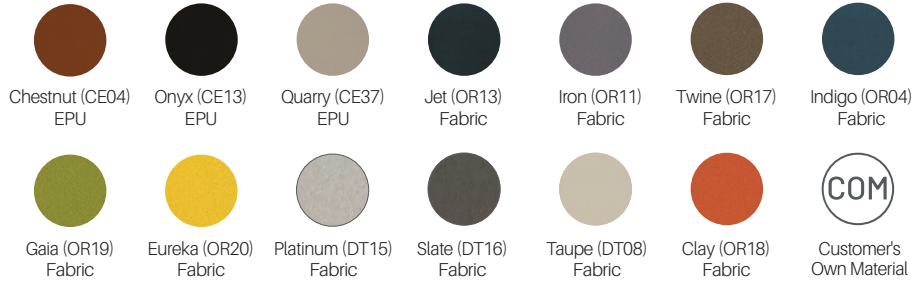

Parent #	Description	Model #	List Price
ECLTCHU	Enclude Task Chair 1 2 4 7 *	ECLTCHU	988.00

Seat Height: 18" - 22"
 Seat: 18"W x 18"D
 Back: 17.5"W x 18.5"H
 Overall : 25"W x 25"D x 34.5" - 38"H

Option	Upcharge
Basic Mechanism	N/C
Deluxe Mechanism	355.00
Headrest	111.00
Standard Caster	N/C
Hard Floor Caster	N/C
Hard Floor Premium	65.00

Model	Back Mesh	Seat Fabric	Headrest	Headrest Fabric	Mechanism	Caster Option
ECLTCHU	BU - Blue Mesh GN - Green Mesh GR - Gray Mesh ON - Onyx Mesh TN - Tan Mesh	See above for Fabric Options	N - Without Headrest Y - With Headrest	See above for Fabric Options *for no headrest, leave blank	BM - Basic Mech ST - Deluxe Side-Tension Mech	ST - Standard Carpet HF - Hard Floor HFP - Hard Floor Premium
Example: ECLTCHU+	BU+	OR13+	Y+	OR13+	ST+	HFP



Parent #	Description	Model #	List Price								
ECLMSTU	Enclude Multi-Purpose Stool ① *	ECLTSTU	1,047.00								
PROP 65	Seat Height: 23"- 33" Seat: 18"W x 18"D Back: 18"W x 18"H Overall: 28"W x 28"D x 38"- 48"H										
	<table border="1"> <thead> <tr> <th>Option</th> <th>Upcharge</th> </tr> </thead> <tbody> <tr> <td>Standard Caster</td> <td>N/C</td> </tr> <tr> <td>Hard Floor Caster</td> <td>N/C</td> </tr> <tr> <td>Hard Floor Premium</td> <td>65.00</td> </tr> </tbody> </table>	Option	Upcharge	Standard Caster	N/C	Hard Floor Caster	N/C	Hard Floor Premium	65.00		
Option	Upcharge										
Standard Caster	N/C										
Hard Floor Caster	N/C										
Hard Floor Premium	65.00										

Model	Back Mesh	Seat Fabric	Caster Option
ECLTSTU	BU - Blue Mesh ON - Onyx Mesh GN - Green Mesh TN - Tan Mesh GR - Gray Mesh	See page 16 for Fabric Options	ST - Standard Carpet HF - Hard Floor HFP - Hard Floor Premium
Example: E C L M S T U +	B U +	O R 1 3 +	H F P



Parent #	Description	Model #	List Price								
ECLMCHU	Enclude Multi-Purpose Chair ① *	ECLMCHU	901.00								
PROP 65	Seat Height: 17"- 22" Seat: 18"W x 18"D Back: 18"W x 18"H Overall: 28"W x 28"D x 32"- 37"H										
	<table border="1"> <thead> <tr> <th>Option</th> <th>Upcharge</th> </tr> </thead> <tbody> <tr> <td>Standard Caster</td> <td>N/C</td> </tr> <tr> <td>Hard Floor Caster</td> <td>N/C</td> </tr> <tr> <td>Hard Floor Premium</td> <td>65.00</td> </tr> </tbody> </table>	Option	Upcharge	Standard Caster	N/C	Hard Floor Caster	N/C	Hard Floor Premium	65.00		
Option	Upcharge										
Standard Caster	N/C										
Hard Floor Caster	N/C										
Hard Floor Premium	65.00										

Model	Back Mesh	Seat Fabric	Caster Option
ECLMCHU	BU - Blue Mesh ON - Onyx Mesh GN - Green Mesh TN - Tan Mesh GR - Gray Mesh	See page 16 for Fabric Options	ST - Standard Carpet HF - Hard Floor HFP - Hard Floor Premium
Example: E C L M C H U +	B U +	O R 1 3 +	H F P

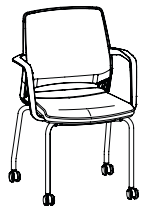

Parent #	Description	Color	Model #	List Price Ea.	List Carton Price	Quantity Per Carton								
ECLGCHU	Enclude Guest Chair 2/CTN	Black Frame	ECLGCHU	--	1,625.00	2								
PROP 65	Seat Height: 18" Seat: 18"W x 18"D Back: 18"W x 18"H Overall: 23.5"W x 23.5"D x 33.5"H													
	<table border="1"> <thead> <tr> <th>Option</th> <th>Upcharge</th> </tr> </thead> <tbody> <tr> <td>Standard Caster</td> <td>N/C</td> </tr> <tr> <td>Hard Floor Caster</td> <td>N/C</td> </tr> <tr> <td>Hard Floor Premium</td> <td>65.00</td> </tr> </tbody> </table>	Option	Upcharge	Standard Caster	N/C	Hard Floor Caster	N/C	Hard Floor Premium	65.00					
Option	Upcharge													
Standard Caster	N/C													
Hard Floor Caster	N/C													
Hard Floor Premium	65.00													

Model	Back Mesh	Seat Fabric	Caster Option
ECLGCHU	BU - Blue Mesh ON - Onyx Mesh GN - Green Mesh TN - Tan Mesh GR - Gray Mesh	See page 16 for Fabric Options	ST - Standard Carpet HF - Hard Floor HFP - Hard Floor Premium
Example: E C L G C H U +	B U +	O R 1 3 +	H F P

Cohere Fabric Options



Black (BL)
Fabric



Blue (BU)
Fabric



Gray (GR)
Fabric



Parent #	Description	Color	Model #	List Price
COHTCHU	Cohere Task Chair Seat Height: 20.75" Seat: 19"W x 20"D Overall: 27"W x 26"D x 44.5"H	Black	COHTCHUBL	1,350.00
		Blue	COHTCHUBU	
		Gray	COHTCHUGR	

Welle Fabric & Base Options

Black (BL)



Fabric



Plastic Base

Blue (BU)



Fabric



Plastic Base

Gray (GR)



Fabric



Plastic Base

Green (GN)



Fabric



Plastic Base

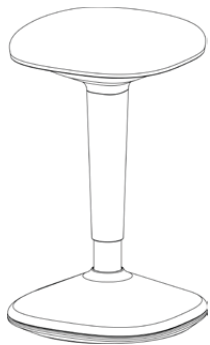

Parent #	Description	Color	Model #	List Price
WELPRSU 	Welle Active Stool Seat Height: 22.75"-31.25" Overall: 13"W x 13"D x 31.25"H	Black	WELPRSUBL	575.00
		Blue	WELPRSUBU	
		Green	WELPRSUGN	
		Gray	WELPRSUGR	

Fabric Options

Leg Options

HPL Laminate + Matching Edge Color Option



Platinum (DT15)
Fabric



Slate (DT16)
Fabric

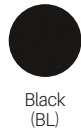

Black
(BL)



Asian Night
(ASNT)
HPL



Battleship
(BTTL)
HPL



Biltmore Cherry
(BMCH)
HPL



Black
(BLAK)
HPL



Carbon Mesh
(CARM)
HPL



Columbian
Walnut (CLWN)
HPL



Designer White
(DSWT)
HPL



Fashion Gray
(FNGY)
HPL



Taupe (DT08)
Fabric



Field Elm
(FLEL)
HPL



Fusion Maple
(FUMP)
HPL



Landmark
Wood (LDMK)
HPL



Pepperdust
(PPDS)
HPL



Pinnacle Walnut
(PNWN)
HPL



Portico Teak
(PRTK)
HPL



River Cherry
(RVCH)
HPL



Open Line
Laminate

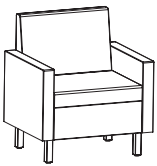

Parent #	Description	Model #	List Price
MRJL1BU	Murj Lounge Chair, Both Arms Seat: 24"W x 19"D x 18.5"H Back: 24"W x 15.25"H Arm: 6"H Overall: 30"W x 24"D x 33.75"H	MRJL1BU	1,740.00

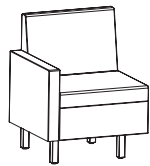

Parent #	Description	Model #	List Price
MRJL1RU	Murj Lounge Chair, Right Arm Seat: 24"W x 19"D x 18.5"H Back: 24"W x 15.25"H Arm: 6"H Overall: 27"W x 24"D x 33.75"H	MRJL1RU	1,610.00

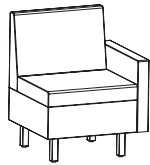

Parent #	Description	Model #	List Price
MRJL1LU	Murj Lounge Chair, Left Arm Seat: 24"W x 19"D x 18.5"H Back: 24"W x 15.25"H Arm: 6"H Overall: 27"W x 24"D x 33.75"H	MRJL1LU	1,610.00

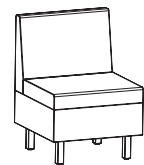

Parent #	Description	Model #	List Price
MRJL1AU	Murj Lounge Chair, Armless Seat: 24"W x 19"D x 18.5"H Back: 24"W x 15.25"H Overall: 24"W x 24"D x 33.75"H	MRJL1AU	1,479.00

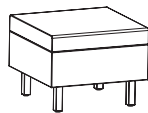

Parent #	Description	Model #	List Price
MRJL1OU	Murj Lounge Ottoman Overall: 24"W x 24"D x 18.5"	MRJL1OU	1,218.00

SEATING

Model	Fabric
MRJL1BU - Lounge Chair Both Arms MRJL1LU - Lounge Chair Left Arm MRJL1RU - Lounge Chair Right Arm MRJL1AU - Lounge Chair Armless MRJL1OU - Lounge Ottoman	DT08 - Taupe DT15 - Platinum DT16 - Slate
Example: MRJLGBU +	DT08

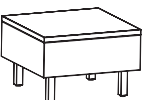

Parent #	Description	Model #	List Price
MRJL1TU	Murj Lounge Table Overall: 24"W x 24"D x 18.5"	MRJL1TU	1,218.00

TABLE

Model	Fabric	Laminate Top
MRJL1TU - Lounge Table	DT08 - Taupe DT15 - Platinum DT16 - Slate	See above for HPL laminate with match 3mm edgeband choices
Example: MRJLGTU +	DT08 +	ASNT

Laminate + Matching Edge Color Option



Base Color Options



Cutout Options

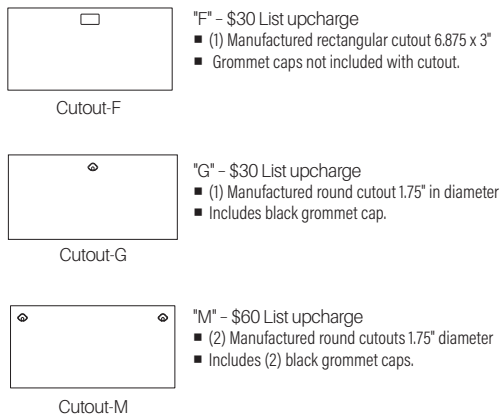

Laminate Edge Type

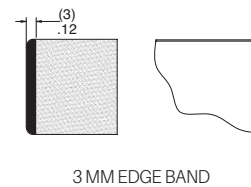

Note: All non-standard cutouts (other than above) will be reviewed to determine if the cutout does not interfere with the base, degrade table strength or cause imbalance. Contact specials@onsemblesolutions.com for quote request and drawing sign-off will be required before order is processed.

- A cohesive collection allowing specifiers to achieve a similar look throughout a space
- 1.125" thick tops with matching 3mm edge banding
- Tables available in Flip, T-Leg, Post-Leg, Café, Bistro, and Conference
- Flip tables feature dual-sided levers for a quick flip of the top
- Flip tables nest for compact storage
- Sitting-height tables are 29"H
- Bistro café tables are 42"H
- Textured SILVER powder coat bases
- Glide option includes 4 adjustable glides
- Caster options include 4 locking casters
- Manufactured cutouts and power option available

Akord Multi-Purpose Tables

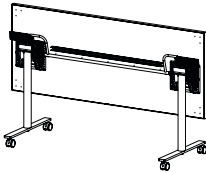
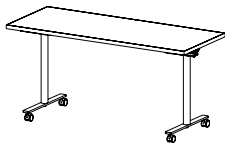

Akord Flip Base Table w/Casters

Model	Description	List Price
AKDFLP4818REC	Akord 48" x 18" Flip Base	1,862.00
AKDFLP4824REC	Akord 48" x 24" Flip Base	1,909.00
AKDFLP4830REC	Akord 48" x 30" Flip Base	2,027.00
AKDFLP5418REC	Akord 54" x 18" Flip Base	1,891.00
AKDFLP5424REC	Akord 54" x 24" Flip Base	1,945.00
AKDFLP5430REC	Akord 54" x 30" Flip Base	2,085.00
AKDFLP6018REC	Akord 60" x 18" Flip Base	2,008.00
AKDFLP6024REC	Akord 60" x 24" Flip Base	2,064.00
AKDFLP6030REC	Akord 60" x 30" Flip Base	2,229.00

Model	Description	List Price
AKDFLP6618REC	Akord 66" x 18" Flip Base	2,069.00
AKDFLP6624REC	Akord 66" x 24" Flip Base	2,123.00
AKDFLP6630REC	Akord 66" x 30" Flip Base	2,252.00
AKDFLP7218REC	Akord 72" x 18" Flip Base	2,145.00
AKDFLP7224REC	Akord 72" x 24" Flip Base	2,212.00
AKDFLP7230REC	Akord 72" x 30" Flip Base	2,372.00



Model	Top Width	Top Depth	Top Shape	Leg Color	Power Cut Out	Top Color/Pattern
AKDFLP	48 54 60 66 72	18 24 30	REC - Rectangle	See page 20 for Base Color options	N - None F - Rectangle Cutout (\$30 upcharge) G - Center Rnd Cutout (\$30 upcharge) M - Left/Right Rnd Cutout (\$60 upcharge)	See page 20 for HPL laminate with matching 3mm edgeband choices
Example: AKDFLP+	60+	24+	REC+	GRAY+	F+	ASNT

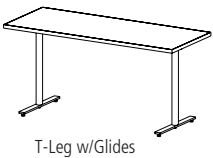

T-Leg w/Glides

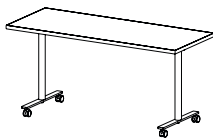

T-Leg w/Casters

Akord T-Leg Table

Model	Description	List Price
AKDFXT4818REC	Akord 48" x 18" T-Leg	1,432.00
AKDFXT4824REC	Akord 48" x 24" T-Leg	1,479.00
AKDFXT4830REC	Akord 48" x 30" T-Leg	1,597.00
AKDFXT5418REC	Akord 54" x 18" T-Leg	1,462.00
AKDFXT5424REC	Akord 54" x 24" T-Leg	1,514.00
AKDFXT5430REC	Akord 54" x 30" T-Leg	1,653.00
AKDFXT6018REC	Akord 60" x 18" T-Leg	1,563.00
AKDFXT6024REC	Akord 60" x 24" T-Leg	1,618.00
AKDFXT6030REC	Akord 60" x 30" T-Leg	1,784.00

Model	Description	List Price
AKDFXT6618REC	Akord 66" x 18" T-Leg	1,623.00
AKDFXT6624REC	Akord 66" x 24" T-Leg	1,677.00
AKDFXT6630REC	Akord 66" x 30" T-Leg	1,806.00
AKDFXT7218REC	Akord 72" x 18" T-Leg	1,653.00
AKDFXT7224REC	Akord 72" x 24" T-Leg	1,721.00
AKDFXT7230REC	Akord 72" x 30" T-Leg	1,881.00



Model	Top Width	Top Depth	Top Shape	Casters/Glides	Leg Color	Power Cut Out	Top Color/Pattern
AKDFXT	48 54 60 66 72	18 24 30	REC - Rectangle	CA - Casters GL - Glides	See page 20 for Base Color options	N - None F - Rectangle Cutout G - Center Rnd Cutout M - Left/Right Rnd Cutout	See page 20 for HPL laminate with matching 3mm edgeband choices
Example: AKDFXT+	60+	24+	REC+	CA+	GRAY+	F+	ASNT

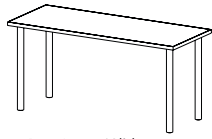

Post-Leg w/Glides

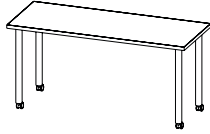

Post-Leg w/Casters

Akord Post-Leg Table

Model	Description	List Price
AKDFXP4818REC	Akord 48" x 18" Post Leg	1,277.00
AKDFXP4824REC	Akord 48" x 24" Post Leg	1,324.00
AKDFXP4830REC	Akord 48" x 30" Post Leg	1,442.00
AKDFXP5418REC	Akord 54" x 18" Post Leg	1,307.00
AKDFXP5424REC	Akord 54" x 24" Post Leg	1,359.00
AKDFXP5430REC	Akord 54" x 30" Post Leg	1,498.00
AKDFXP6018REC	Akord 60" x 18" Post Leg	1,408.00
AKDFXP6024REC	Akord 60" x 24" Post Leg	1,463.00
AKDFXP6030REC	Akord 60" x 30" Post Leg	1,629.00

Model	Description	List Price
AKDFXP6618REC	Akord 66" x 18" Post Leg	1,469.00
AKDFXP6624REC	Akord 66" x 24" Post Leg	1,523.00
AKDFXP6630REC	Akord 66" x 30" Post Leg	1,651.00
AKDFXP7218REC	Akord 72" x 18" Post Leg	1,498.00
AKDFXP7224REC	Akord 72" x 24" Post Leg	1,564.00
AKDFXP7230REC	Akord 72" x 30" Post Leg	1,726.00



Model	Top Width	Top Depth	Top Shape	Casters/Glides	Leg Color	Power Cut Out	Top Color/Pattern
AKDFXP	48 54 60 66 72	18 24 30	REC - Rectangle	CA - Casters GL - Glides	See page 20 for Base Color options	N - None F - Rectangle Cutout G - Center Rnd Cutout M - Left/Right Rnd Cutout	See page 20 for HPL laminates with matching 3mm edgeband choices
Example: <u>AKDFXP</u> +	<u>60</u> +	<u>24</u> +	<u>REC</u> +	<u>CA</u> +	<u>GRAY</u> +	<u>F</u> +	<u>ASNT</u>

Akord X-Base Table

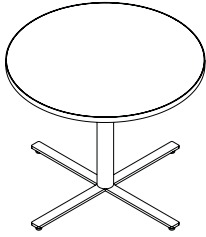

Model	Description	List Price
AKDXBB36RND	Akord 36" Round Top, X-Base 42"H	1,608.00
AKDXBB36SQR	Akord 36" Square Top, X-Base 42"H	1,608.00
AKDXBB42RND	Akord 42" Round Top, X-Base 42"H	1,761.00
AKDXBB42SQR	Akord 42" Square Top, X-Base 42"H	1,761.00
AKDXBS36RND	Akord 36" Round Top, X-Base 29"H	1,533.00
AKDXBS36SQR	Akord 36" Square Top, X-Base 29"H	1,533.00
AKDXBS42RND	Akord 42" Round Top, X-Base 29"H	1,688.00
AKDXBS42SQR	Akord 42" Square Top, X-Base 29"H	1,688.00



Model	Top Size	Top Shape	Leg Color	Top Color/Pattern
AKDXBS - Sitting Height AKDXBB - Bar Height	36 42	RND - Round SQR - Square	See page 20 for Base Color options	See page 20 for HPL laminates with matching 3mm edgeband choices
Example: AKDXBS +	3 6 +	RND +	GRAY +	ASNT

Akord Disc-Base Table

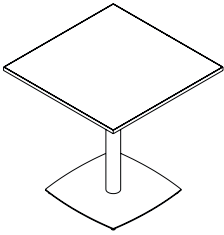

Model	Description	List Price
AKDDBB36RND	Akord 36" Round Top, Disc-Base 42"H	1,693.00
AKDDBB36SQR	Akord 36" Square Top, Disc-Base 42"H	1,693.00
AKDDBB42RND	Akord 42" Round Top, Disc-Base 42"H	2,003.00
AKDDBB42SQR	Akord 42" Square Top, Disc-Base 42"H	2,003.00
AKDDBS36RND	Akord 36" Round Top, Disc-Base 29"H	1,620.00
AKDDBS36SQR	Akord 36" Square Top, Disc-Base 29"H	1,620.00
AKDDBS42RND	Akord 42" Round Top, Disc-Base 29"H	1,928.00
AKDDBS42SQR	Akord 42" Square Top, Disc-Base 29"H	1,928.00



Model	Top Size	Top Shape	Leg Color	Top Color/Pattern
AKDDBS - Sitting Height AKDDBB - Bar Height	36 42	RND - Round SQR - Square	See page 20 for Base Color options	See page 20 for HPL laminates with matching 3mm edgeband choices
Example: AKDDBS +	3 6 +	RND +	GRAY +	ASNT

Akord Conference Table

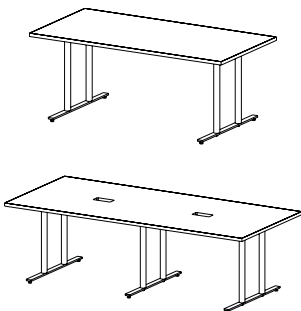

Model	Description	List Price
AKDCNF7236REC	Akord 72" x 36" Conference 29"H	2,387.00
AKDCNF8442REC	Akord 84" x 42" Conference 29"H	2,654.00
AKDCNF9642REC	Akord 96" x 42" Conference 29"H	3,537.00



Model	Top Size	Top Shape	Leg Color	Power Cut Out	Top Color/Pattern
AKDCNF	7236 8442 9642	REC - Rectangle	See page 20 for Base Color options	N - None F - Rectangle Cutout	See page 20 for HPL laminates with matching 3mm edgeband choices
Example: AKDCNF +	7 2 3 6 +	REC +	GRAY +	F +	ASNT

Akord Table Collection

AKORD



PWR110V



PWRUSBAC

Model	Description	Color	List Price
PWR110VBL	Single Power Outlet	Black	165.00
PWR110VWH	Single Power Outlet	White	165.00
PWRUSBACBL	(1) USB-A/(1) USB-C Port	Black	513.00
PWRUSBACWH	(1) USB-A/(1) USB-C Port	White	513.00
PWREDGBL	NEW (2) 110V, (1) USB-A, (1) USB-C, Clamp Mount	Black	644.00
PWREDGWH	NEW (2) 110V, (1) USB-A, (1) USB-C, Clamp Mount	White	644.00
PWRISBL	NEW (2) 110V, (2) USB-A, (2) USB-C, Wall plug-In	Black	1,018.00
PWRISWH	NEW (2) 110V, (2) USB-A, (2) USB-C, Wall Plug-In	White	1,018.00
PWRISDCBL	NEW (2) 110V, (2) USB-A, (2) USB-C, Daisy Chain, 60"	Black	1,041.00
PWRISDCWH	NEW (2) 110V, (2) USB-A, (2) USB-C, Daisy Chain, 60"	White	1,041.00
PWRDCSL	NEW Daisy Chain Starter Link (Required to start chain)		1,122.00
PWREXT	NEW Daisy Chain Extension, 12"		157.00

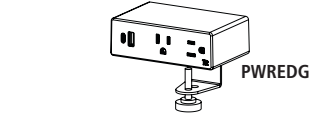

PWREDG

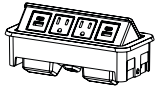

PWRIS

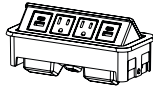

PWRISDC

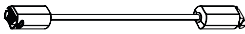
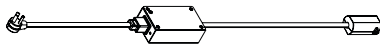

For tables greater than 60" in length:

Connect up to 8 Daisy Chain Power/Data Modules (PWRISDC) plus 12" Extension(s) (PWREXT) to each Daisy Chain Power Infeed (PWRDCSL)

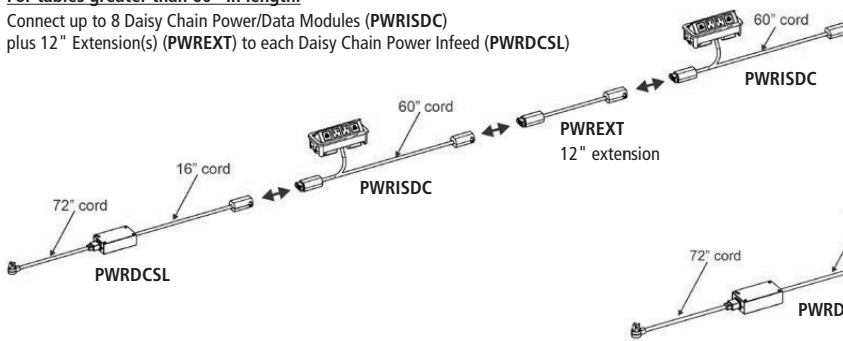

For tables 60" or shorter in length:

Connect up to 8 Daisy Chain Power/Data Modules (PWRISDC) to each Daisy Chain Power Infeed (PWRDCSL)

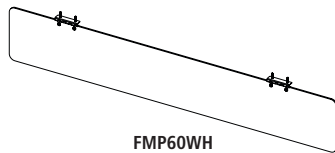
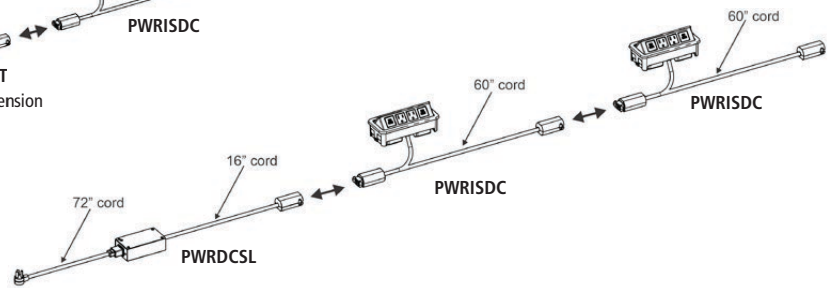

FMP60WH

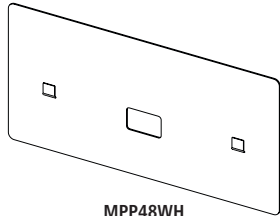

MPP48WH

Model	Description	Size	List Price
FMP48WH PROP 65	Flip Modesty Panel for 48" and 54" Tables	47.5"W x 11.5"H	468.00
FMP60WH PROP 65	Flip Modesty Panel for 60" and 66" Tables	59.5"W x 11.5"H	510.00
FMP72WH PROP 65	Flip Modesty Panel for 72" Table	71.5"W x 11.5"H	505.00
MPP48WH PROP 65	Privacy Modesty Panel 48" and 54" Tables	47.5"W x 23.5"H	416.00
MPP60WH PROP 65	Privacy Modesty Panel for 60" and 66" Tables	59.5"W x 23.5"H	512.00
MPP72WH PROP 65	Privacy Modesty Panel for 72" Table	71.5"W x 23.5"H	611.00



AKDWMCSL

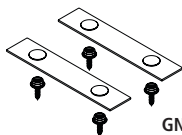

GNG1

Model	Description	Size	List Price
AKDWMCSL NEW	Akord Wire Management Cover, Silver Finish	2.25"W x 18"H x .25"D	131.00
GNG1 NEW	Akord Ganging Connectors, 5 sets	5"W x 7"D	209.00

Laminate + Matching Edge Color Option

Base Options

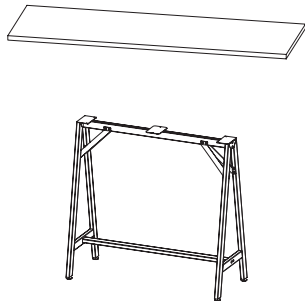

Jibe Top SKU # Formula

Model	Top Width	Top Depth	Top Shape	Base Color	Top Color/Pattern
JBEAFB	60 - 60" 72 - 72"	20 - 20" 24 - 24"	REC - Rectangle	BL - Black SL - Silver	See above for HPL laminate
Example: J B E A F B +	6 0 +	2 0 +	R E C +	B L +	A S N T

Ex: JBEAFB6020RECBLASNT – Jibe 60x20" Top in Asian Night with Black Base

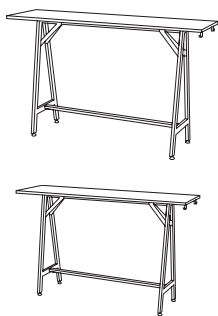

Model	Description	Size	List Price
JBEAFB6020REC	Jibe A-Frame Bar Height Table	60"W x 20"D x 42"H	1,023.00
JBEAFB6024REC	Jibe A-Frame Bar Height Table	60"W x 24"D x 42"H	1,136.00
JBEAFB7220REC	Jibe A-Frame Bar Height Table	72"W x 20"D x 42"H	1,213.00
JBEAFB7224REC	Jibe A-Frame Bar Height Table	72"W x 24"D x 42"H	1,349.00

Konverg Top & Base Options

Maple Top, Blue Base (MPIBU)



Top



Base

Walnut Top, Green Base (WLGN)



Top



Base

Walnut Top, White Base (WLWH)



Top



Base



Parent #	Description	Color	Model #	List Price
KVGCOF30RND 	Konverg Coffee Table Overall : 30"W x 30"D x 16"H	Maple Top, Blue Base Walnut Top, Green Base Walnut Top, White Base	KVGCOF30RNDMPIBU KVGCOF30RNDWLGN KVGCOF30RNDWLWH	750.00



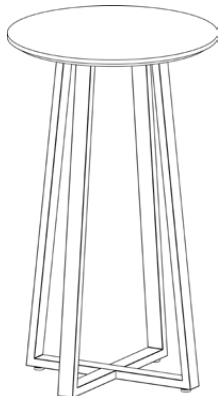

Parent #	Description	Color	Model #	List Price
KVGEND22RND 	Konverg End Table Overall : 22"W x 22"D x 25"H	Maple Top, Blue Base Walnut Top, Green Base Walnut Top, White Base	KVGEND22RNDMPIBU KVGEND22RNDWLGN KVGEND22RNDWLWH	675.00

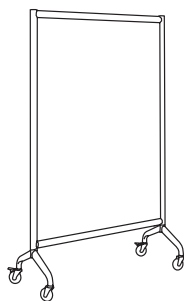

Parent #	Description	Color	Model #	List Price
KVGBAR24RND 	Konverg Bar Table Overall : 24"W x 24"D x 41"H	Maple Top, Blue Base Walnut Top, Green Base Walnut Top, White Base	KVGBAR24RNDMPIBU KVGBAR24RNDWLGN KVGBAR24RNDWLWH	900.00

IDYA WHITEBOARD COLLECTION



Parent #	Description	Model #	List Price
IDYWB3654	Mobile Whiteboard Screen Overall: 36"W x 16"D x 54"H	IDYWB3654SL	2,400.00
IDYWB4254	Mobile Whiteboard Screen Overall: 42"W x 16"D x 54"H	IDYWB4254SL	2,500.00
IDYWB3666	Mobile Whiteboard Screen Overall: 36"W x 16"D x 66"H	IDYWB3666SL	2,600.00
IDYWB4266	Mobile Whiteboard Screen Overall: 42"W x 16"D x 66"H	IDYWB4266SL	2,700.00
IDYERAGR	Screen Eraser Tray 	IDYERAGR	50.00



LIGHTING

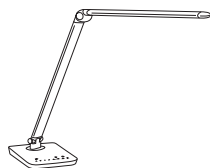

Parent #	Description	Color	Model #	List Price
LULDLP	Lulli LED Desk Lamp  5"W x 16"D x 16.75"H	Black Silver White	LULDLPBL LULDLPPL LULDLPWH	300.00

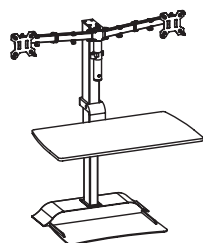

Parent #	Description	Color	Model #	List Price
ACCSSE	Accend Desktop Monitor Lift  Dual Monitor Arms Overall: 27.75"W x 22"D x 18.5-37.25"H	White	ACCSSEWH	1,900.00

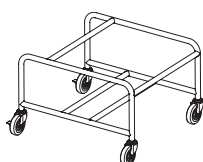

Parent #	Description	Model #	List Price
CRTSLD	Sled Base Stacking Chair Cart  Can stack 20 units depending on the chair Overall: 23.5"W x 27.5"D x 17"H	CRTSLDSL	245.00

Color Options



Onyx
(ONYX)



Graphite
(GRPT)



Granite
(GRNT)



Midnight Blue
(MNBL)



Cream
(CRME)

- All models have Blade Feet: 2.25"W x 18"D x .375"H
- Solid, Matrix and Chain Patterns are PET Material

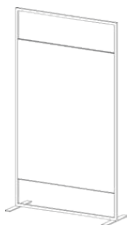

Parent #	Description	Dimensions	Model #	List Price
FSDSD	Solid Surface	Frame Size: 36"W x 72"H, Screen Size: 60"H	FSDSD3672	4,525.00
		Frame Size: 48"W x 72"H, Screen Size: 60"H	FSDSD4872	4,795.00
		Frame Size: 36"W x 84"H, Screen Size: 60"H	FSDSD3684	4,835.00
		Frame Size: 48"W x 84"H, Screen Size: 60"H	FSDSD4884	5,110.00

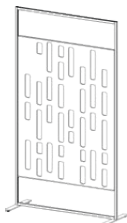

Parent #	Description	Dimensions	Model #	List Price
FSDMX	Matrix Pattern	Frame Size: 36"W x 72"H, Screen Size: 60"H	FSDMX3672	5,288.00
		Frame Size: 48"W x 72"H, Screen Size: 60"H	FSDMX4872	5,526.00
		Frame Size: 36"W x 84"H, Screen Size: 60"H	FSDMX3684	5,831.00
		Frame Size: 48"W x 84"H, Screen Size: 60"H	FSDMX4884	6,069.00

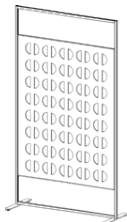

Parent #	Description	Dimensions	Model #	List Price
FSDCN	Chain Pattern	Frame Size: 36"W x 72"H, Screen Size: 60"H	FSDCN3672	5,288.00
		Frame Size: 48"W x 72"H, Screen Size: 60"H	FSDCN4872	5,526.00
		Frame Size: 36"W x 84"H, Screen Size: 60"H	FSDCN3684	5,831.00
		Frame Size: 48"W x 84"H, Screen Size: 60"H	FSDCN4884	6,069.00

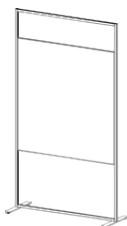

Parent #	Description	Dimensions	Model #	List Price
FSDMB	Markerboard Surface	Frame Size: 36"W x 72"H, Screen Size: 48"H	FSDMB3672	5,387.00
		Frame Size: 48"W x 72"H, Screen Size: 48"H	FSDMB4872	5,523.00
		Frame Size: 36"W x 84"H, Screen Size: 48"H	FSDMB3684	5,856.00
		Frame Size: 48"W x 84"H, Screen Size: 48"H	FSDMB4884	5,992.00

Model	Width	Height	Panel Color
FSDSD - Solid	36	72	ONYX - Onyx
FSDMX - Matrix Pattern	48	84	GRPT - Graphite
FSDCH - Chain Pattern			GRNT - Granite
			MNBL - Midnight Blue
			CRME - Cream
FSDMB - Marker Board			DRYE - Markerboard Only
Example:			
<u> </u> <u> </u> <u> </u> <u> </u> <u> </u> <u> </u> <u> </u> +	<u> </u> <u> </u> +	<u> </u> <u> </u> +	<u> </u> <u> </u> <u> </u> <u> </u>

Color Options



Granite (GRNT)



Graphite (GRPT)

- PET Material
- Handle Cutout 2" Radius
- Feet: 4" W x 2" H
- Available in Granite and Graphite

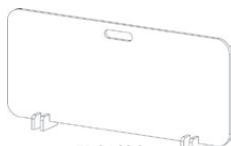

FDS1636



FDS1648



FDS1660

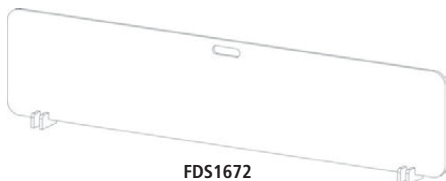

FDS1672

Model	Size	List Price
FDS1636	Screen Size: 36"W x 16"H	70.00
FDS1648	Screen Size: 48"W x 16"H	80.00
FDS1660	Screen Size: 60"W x 16"H	100.00
FDS1672	Screen Size: 72"W x 16"H	110.00

Model	Color
FDS1636 - Desk Screen 36" FDS1648 - Desk Screen 48" FDS1660 - Desk Screen 60" FDS1672 - Desk Screen 72"	GRNT-Granite GRPT-Graphite
Example: F D S 1 5 3 6 +	G R N T

Laminate + Matching Edge Color Option



Base Options

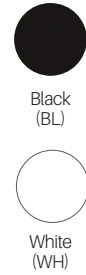

- 36" lockers available with two 18" doors with internal dividing shelf
- Keyed (random - master key available) or Digital Locks (revolving code)
- Individual locker modules ship fully assembled
- Concealed adjustable door hinges
- Work surfaces are constructed with 1.125" particle board with HPL and 3mm PVC edge banding
- 4 leveling glides for easy alignment (per locker)
- Ganging hardware included for front to back, side to side, and top to bottom connection
- Optional toe-kick for use with UNYLOCFS18 & UNYLOCFS36
- All steel is finished with powder coat paint (white or textured black)

Laminate Edge Type

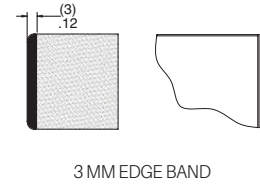

Fabric Options



FREE-STANDING LOCKERS

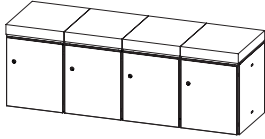

Parent #	Description	Model #	List Price
UNY01	Bench with Cushion	UNY01	4,612.00



Locker Height: 18.5"
 Seat Size: 60"W x 18"D
 Overall Size: 60"W x 18"D x 20.5"H

Option	Upcharge
Door Material Steel or Laminate (HPL)	N/C
Lock Type	
Keyed Lock	N/C
Digital Lock - DL (Price is Per Lock)	106.00
Metal Color	
White Powder Coat	N/C
Black Textured Powder Coat	N/C

Parent	Cabinet Color	Door Material	Door Color	Lock Type	Fabric
UNY01	WH - White BL - Black Textured	STE - Steel LAM - Laminate	See page 29 for laminate with matching edgeband choices	KL - Keyed Lock DL - Digital Lock	See page 29 for fabric options
Example: UNY01+	BL+	LAM+	CLWN+	DL+	OR11

STAND-ALONE LOCKER OPTIONS

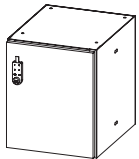

Parent #	Description	Model #	List Price
UNYLOCFS18	18" Single Locker	UNYLOCFS18	880.00



Overall Size: 15"W x 18"D x 18.5"H

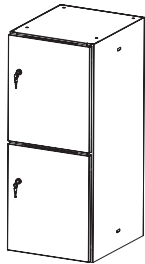

Parent #	Description	Model #	List Price
UNYLOCFS36	36" Single Locker	UNYLOCFS36	1,639.00



Overall Size: 15"W x 18"D x 36.5"H
 Number of Doors for 36" Lockers: Double Door-DD

Option	Upcharge
Door Material Steel	N/C
Lock Type	
Keyed Lock	N/C
Digital Lock - DL (Price is Per Lock)	106.00
Metal Color	
White Powder Coat	N/C
Black Textured Powder Coat	N/C

Parent	Number of Doors*	Cabinet Color	Door Material	Door Color	Lock Type
UNYLOCFS18 UNYLOCFS36	DD-Double Door SD-Single Door	WH - White BL - Black Textured	STE - Steel LAM - Laminate	See page 29 for laminate with matching edgeband choices	KL - Keyed Lock DL - Digital Lock
Example: UNYLOCFS36+	DD+	BL+	LAM+	DSWT+	KD

*Single Door (SD) only available on UNYLOCFS36

Unyon Storage Collection

UNYON

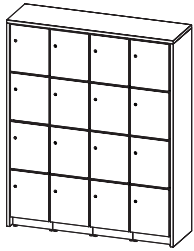

Parent #	Description	Model #	List Price
UNY06 	Locker Wall Overall Size: Overall Size: 62.5"W x 18.5"D x 77.5"H Number of Doors for 36" Lockers: Double Door-DD	UNY06	15,687.00
Option		Upcharge	
Door Material Steel		N/C	
Lock Type		N/C	
Keyed Lock		N/C	
Digital Lock - DL (Price is Per Lock)		106.00	
Metal Color		N/C	
White Powder Coat		N/C	
Black Textured Powder Coat		N/C	

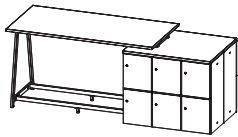

Parent #	Description	Model #	List Price
UNY08 	A-Frame w/Riser (Long) Counter Size: 75"W x 37"D Locker Surface Height: 37.75"H Overall Size: 105"W x 37"D x 41.5"H Number of Doors for 36" Lockers: Double Door-DD	UNY08	15,244.00

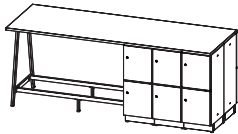

Parent #	Description	Model #	List Price
UNY10 	A-Frame Bistro (Long) Counter Size: 105"W x 37"D Overall Size: 105"W x 37"D x 41.5"H Number of Doors for 36" Lockers: Double Door-DD	UNY10	15,103.00

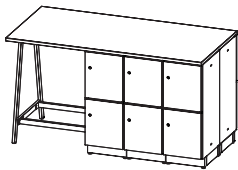

Parent #	Description	Model #	List Price
UNY11 	A-Frame Bistro (Short) Counter Size: 75"W x 37"D Overall Size: 75"W x 37"D x 41.5"H Number of Doors for 36" Lockers: Double Door-DD	UNY11	13,415.00

Option	Upcharge
Door Material Steel	N/C
Lock Type	
Keyed Lock	N/C
Digital Lock - DL (Price is Per Lock)	106.00
Metal Color	
White Powder Coat	N/C
Black Textured Powder Coat	N/C

Parent	Base Color	Worksurface and Waterfall Color (HPL)	Number of Doors	Door Material	Door Color (HPL only)	Lock Type
UYN06 UYN08 UYN10 UYN11	WH - White BL - Black Textured	See page 29 for laminate with matching edgeband choices	DD - Double Door SD - Single Door	STE - Steel LAM - Laminate	See page 29 for laminate with matching edgeband choices *for Steel Door (STE), leave blank	KL - Keyed Lock DL - Digital Lock
Example:						
UYN06+	BL+	OR18+	DD+	LAM+	OR18+	DL

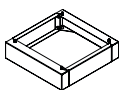

Parent #	Description	Color	Model #	List Price
UNYTKC 	Toe-Kick Option for UNYLOCFS18 & UNYLOCFS36 Overall Size: 15"W x 15"D x 3.625"H	Black Textured White	UNYTKCBL UNYTKCWH	132.00



Description	Material	Model #	List Price
Replacement Keys 	Replacement Key 201-300* 920000462 Master Key	201-300 920000462	39.00

*When requesting a replacement key the lock/key number, located on the face of the lock, is required.

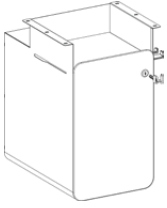

Parent #	Description	Color	Model #	List Price
VYBLOCSU	Vybe Under Mount Desk Storage 14.4"W x 15.9"D x 19.4"H	Granite grey felt door on white metal locker	VYBLOCSUGRNTWH	430.00
		Graphite felt door on black metal locker	VYBLOCSUGRPTBL	

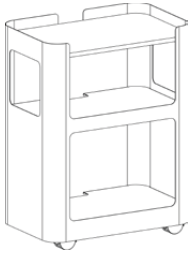

Parent #	Description	Color	Model #	List Price
MOBCART	Mobe Open Shelf Mobile Cabinet 18.1"W x 11.4"D x 23.9"H	White with Walnut top	MOBCARTWLWH	450.00

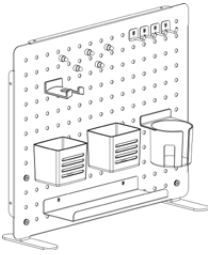

Parent #	Description	Color	Model #	List Price
FRSVERTPB	Desktop Pegboard 20.5"W x 6.2"D x 16.9"H	White	FRSVERTPBWH	150.00
		Black	FRSVERTPBBL	



Parent #	Description	Color	Model #	List Price
ATDVDRMO	Atytude Trolley Vertical Drawers 35.4"W x 15.8"D x 27.6"H	White with White top	ATDVDRMOWHWH	1,600.00



Parent #	Description	Color	Model #	List Price
ATDHDRMO	Atytude Trolley Horizontal Drawers 35.4"W x 15.8"D x 27.6"H	White with White top	ATDHDRMOWHWH	1,600.00

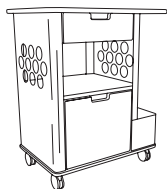



Parent #	Description	Color	Model #	List Price
SPHRSC	Sphyr Rolling Storage Cart Overall Size: 28"W x 20"D x 33.5"H Work Surface: 28"W x 20"D Slide-Out Drawer 1: 15.75"W x 15.75"D x 5"H Slide-Out Drawer 2: 15.75"W x 15.75"D x 13.375"H Side Compartment: 5.5"W x 17.5"D x 7"H	Silver Frame with White Top	SPHRSCWH	1,720.00



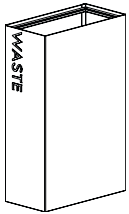

Parent #	Description	Color	Model #	List Price
STRHRD	Half Round Receptacle	White	STRHRDWH	800.00
	23 Gallon Capacity 10.25"W x 20.25"D x 32.25"H Includes: Can, Rim, Liner, and Sheet of 8 Black Decals (two of each option) Decals Included: COMPOST, MIXED RECYCLING, TRASH, WASTE	Silver	STRHRDSL	



Parent #	Description	Color	Model #	List Price
STRREC	Rectangular Receptacle	White	STRRECWH	800.00
	29 Gallon Capacity 10.25"W x 20.25"D x 32.25"H Includes: Can, Rim, Liner, and Sheet of 8 Black Decals (two of each option) Decals Included: COMPOST, MIXED RECYCLING, TRASH, WASTE	Silver	STRRECSL	

Introducing Modix, the innovative solution designed to revolutionize traditional panel and desking systems. Modix seamlessly bridges the gap between technical workstations and front office environments, offering a versatile platform that evolves to meet a variety of needs. Its flexible and adaptive design allows for the creation of customizable, attractive workstations that cater to diverse requirements. Featuring a range of relevant material options and practical features, Modix is the standout choice perfectly designed to meet the evolving needs of modern workspaces.

Laminate + Matching Edge Color Option



Powder Coat



Cutout Options

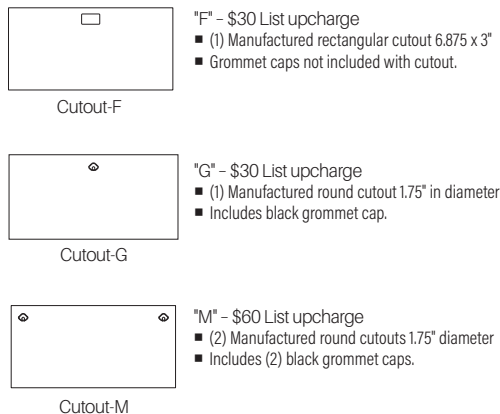

Laminate Edge Type

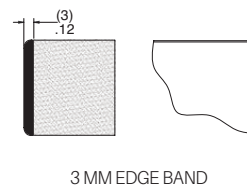

Note: All non-standard cutouts (other than above) will be reviewed to determine if the cutout does not interfere with the base, degrade table strength or cause imbalance. Contact specials@onsemblesolutions.com for quote request and drawing sign-off will be required before order is processed.

Modix Desks Features

Desks have 14" of travel range measuring 26" to 40"H from floor to the top of the work surface. Adjusts in 1" increments with threaded fasteners. Desks come standard with black hardware and black leveling glides; Optional caster kits are available for an additional \$375 list, featuring a set of 4 casters (Item CASKIT4). Casters will add 4" to overall desk height. Desks ship knocked down.

- Standard work surface options include:
HPL (High Pressure Laminate 1.125" thick) with 3mm edge band
- Grommet cutouts are available at an upcharge.
- Additional colors and work surface materials are available - upcharges, minimums and extended lead times may apply. Email specials@onsemblesolutions.com for quotation.
- Integrated cable management trough at the rear of each desk ensures that cords are neatly concealed and organized.
- The trough comes standard in a sleek black finish.

Model	Type	Top Width	Top Depth	Top Shape	Glides/Casters	Base Color	Top Surface Material	Power Cut Out	Top Color/Pattern
MDX - Modix	DSK - Desk	36 42 48 54 60 66 72	24 30 36	REC - Rectangle	GL - Glides CA - Casters	See page 35	LAM - Laminate	N - None M - Left/Right Round Cutout	See page 35
Example: M D X +	D S K +	4 8 +	2 4 +	R E C +	G L +	B L M D +	L A M +	M +	P P D S
Model Number					Configured Options				

Surface Cutout Options (Desks Only)



Cutout-M

- "M" - \$60 List upcharge
- (2) Manufactured round cutouts 1.75" diameter
 - Includes (2) black grommet caps.



36"W Rectangular Desk

Model	Description	List Price
MDXD SK3624REC	36"W x 24"D x 26-40"H Adjustable Height Desk	2,550.00
MDXD SK3630REC	36"W x 30"D x 26-40"H Adjustable Height Desk	2,725.00
MDXD SK3636REC	36"W x 36"D x 26-40"H Adjustable Height Desk	2,900.00

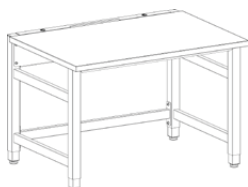

42"W Rectangular Desk

Model	Description	List Price
MDXD SK4224REC	42"W x 24"D x 26-40"H Adjustable Height Desk	2,625.00
MDXD SK4230REC	42"W x 30"D x 26-40"H Adjustable Height Desk	2,800.00
MDXD SK4236REC	42"W x 36"D x 26-40"H Adjustable Height Desk	2,975.00



48"W Rectangular Desk

Model	Description	List Price
MDXDSK4824REC	48"W x 24"D x 26-40"H Adjustable Height Desk	2,700.00
MDXDSK4830REC	48"W x 30"D x 26-40"H Adjustable Height Desk	2,875.00
MDXDSK4836REC	48"W x 36"D x 26-40"H Adjustable Height Desk	3,050.00

54"W Rectangular Desk

Model	Description	List Price
MDXDSK5424REC	54"W x 24"D x 26-40"H Adjustable Height Desk	2,775.00
MDXDSK5430REC	54"W x 30"D x 26-40"H Adjustable Height Desk	2,950.00
MDXDSK5436REC	54"W x 36"D x 26-40"H Adjustable Height Desk	3,125.00



60"W Rectangular Desk

Model	Description	List Price
MDXDSK6024REC	60"W x 24"D x 26-40"H Adjustable Height Desk	2,850.00
MDXDSK6030REC	60"W x 30"D x 26-40"H Adjustable Height Desk	3,025.00
MDXDSK6036REC	60"W x 36"D x 26-40"H Adjustable Height Desk	3,200.00

66"W Rectangular Desk

Model	Description	List Price
MDXDSK6624REC	66"W x 24"D x 26-40"H Adjustable Height Desk	2,925.00
MDXDSK6630REC	66"W x 30"D x 26-40"H Adjustable Height Desk	3,100.00
MDXDSK6636REC	66"W x 36"D x 26-40"H Adjustable Height Desk	3,275.00

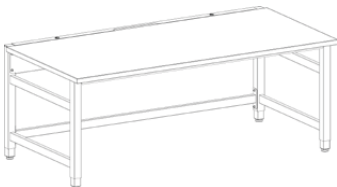

72"W Rectangular Desk

Model	Description	List Price
MDXDSK7224REC	72"W x 24"D x 26-40"H Adjustable Height Desk	3,000.00
MDXDSK7230REC	72"W x 30"D x 26-40"H Adjustable Height Desk	3,175.00
MDXDSK7236REC	72"W x 36"D x 26-40"H Adjustable Height Desk	3,350.00

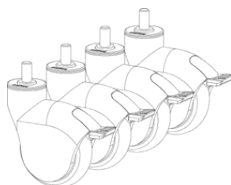

Caster Kit

Model	Description	List Price
CASKIT4	Caster Kit - Set of 4	375.00

Modix Return Features

Returns have 14" of travel range measuring 26" to 40"H from floor to the top of the work surface. Adjusts in 1" increments with threaded fasteners. Returns come standard with black hardware and black leveling glides; no caster option available. Non-handed. Returns ship knocked down.

- Standard work surface options include:
HPL (High Pressure Laminate 1.125" thick) with 3mm edge band.
- Additional colors and work surface materials are available - upcharges, minimums and extended lead times may apply. Email specials@onsemblesolutions.com for quotation.
- Returns feature a flexible design that allows for attachment to desks and tables at multiple increments, accommodating a wide range of space configurations and user needs.

Model	Type	Top Width	Top Depth	Top Shape	Glides	Base Color	Top Surface Material	Power Cut Out	Top Color/Pattern
MDX - Modix	RTN - Return	36 42	18 24	REC - Rectangle	GL - Glides	See page 35	LAM - Laminate	N - None	See page 35
Example: M D X +	R T N +	3 6 +	2 4 +	R E C +	G L +	B L C K +	L A M +	N +	P N W N
Model Number					Configured Options				

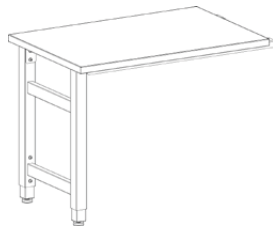

36"W Rectangular Return

Model	Description	List Price
MDXRTN3618REC	36"W x 18"D x 26-40"H Adjustable Height Return	1,275.00
MDXRTN3624REC	36"W x 24"D x 26-40"H Adjustable Height Return	1,450.00

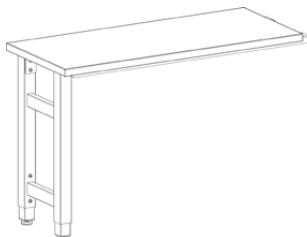

42"W Rectangular Return

Model	Description	List Price
MDXRTN4218REC	42"W x 18"D x 26-40"H Adjustable Height Return	1,350.00
MDXRTN4224REC	42"W x 24"D x 26-40"H Adjustable Height Return	1,525.00

Modix Table Features

Tables have 14" of travel range measuring 26" to 40"H from floor to the top of the work surface. Adjusts in 1" increments with threaded fasteners. Tables come standard with black hardware and black leveling glides; Optional caster kits are available for an additional \$375 list, featuring a set of 4 casters (Item CASKIT4). Casters will add 4" to overall table height. Tables ship knocked down.

- Standard work surface options include:
 - HPL (High Pressure Laminate 1.125" thick) with 3mm edge band.
- Grommet and electrical cutouts are available at an upcharge.
- Additional colors and work surface materials are available - upcharges, minimums and extended lead times may apply. Email specials@onsemblesolutions.com for quotation.
- Optional lower shelves are available on 36", 42", and 48"D tables.
- All tables come equipped with built-in footrests. A single footrest is standard on 24" and 30"D tables, while dual footrests are standard on 36", 42", and 48"D tables.

Model	Type	Top Width	Top Depth	Top Shape	Glides/Casters	Base Color	Top Surface Material	Power Cut Out	Top Color/Pattern
MDX - Modix	TBL - Table	48 54 60 66 72 78 84	24 30 36 42 48	REC - Rectangle	GL - Glides CA - Casters	See page 35	LAM - Laminate	N - None F - Rectangle G - Center Round M - Left/Right Round	See page 35
Example: M D X +	T B L +	8 4 +	4 8 +	R E C +	C A +	J Y O R +	L A M +	F +	D S W T
Model Number					Configured Options				

Surface Cutout Options (Tables Only)

24" & 30" D Tables



Cutout-F

- "F" - \$30 List upcharge
- (1) Manufactured rectangular cutout 6.875 x 3"
 - Grommet caps not included with cutout



Cutout-G

- "G" - \$30 List upcharge
- (1) Manufactured round cutout 1.75" in diameter
 - Includes black grommet cap



Cutout-M

- "M" - \$60 List upcharge
- (2) Manufactured round cutouts 1.75" diameter
 - Includes (2) black grommet caps

36", 42" & 48" D Tables



Cutout-F

- "F" - \$30 List upcharge
- (1) Manufactured rectangular cutout 6.875 x 3"
 - Grommet caps not included with cutout



Cutout-G

- "G" - \$30 List upcharge
- (1) Manufactured round cutout 1.75" in diameter
 - Includes black grommet cap



Cutout-M

- "M" - \$60 List upcharge
- (2) Manufactured round cutouts 1.75" diameter
 - Includes (2) black grommet caps

48"W Rectangular Table

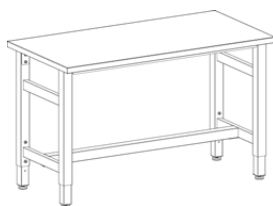

Model	Description	List Price
MDXTBL4824REC	48"W x 24"D x 26-40"H Adjustable Height Table	2,400.00
MDXTBL4830REC	48"W x 30"D x 26-40"H Adjustable Height Table	2,575.00
MDXTBL4836REC	48"W x 36"D x 26-40"H Adjustable Height Table	2,750.00
MDXTBL4842REC	48"W x 42"D x 26-40"H Adjustable Height Table	2,925.00
MDXTBL4848REC	48"W x 48"D x 26-40"H Adjustable Height Table	3,100.00

54"W Rectangular Table

Model	Description	List Price
MDXTBL5424REC	54"W x 24"D x 26-40"H Adjustable Height Table	2,475.00
MDXTBL5430REC	54"W x 30"D x 26-40"H Adjustable Height Table	2,650.00
MDXTBL5436REC	54"W x 36"D x 26-40"H Adjustable Height Table	2,825.00
MDXTBL5442REC	54"W x 42"D x 26-40"H Adjustable Height Table	3,000.00
MDXTBL5448REC	54"W x 48"D x 26-40"H Adjustable Height Table	3,175.00



60"W Rectangular Table

Model	Description	List Price
MDXTBL6024REC	60"W x 24"D x 26-40"H Adjustable Height Table	2,550.00
MDXTBL6030REC	60"W x 30"D x 26-40"H Adjustable Height Table	2,725.00
MDXTBL6036REC	60"W x 36"D x 26-40"H Adjustable Height Table	2,900.00
MDXTBL6042REC	60"W x 42"D x 26-40"H Adjustable Height Table	3,075.00
MDXTBL6048REC	60"W x 48"D x 26-40"H Adjustable Height Table	3,250.00

66"W Rectangular Table

Model	Description	List Price
MDXTBL6624REC	66"W x 24"D x 26-40"H Adjustable Height Table	2,625.00
MDXTBL6630REC	66"W x 30"D x 26-40"H Adjustable Height Table	2,800.00
MDXTBL6636REC	66"W x 36"D x 26-40"H Adjustable Height Table	2,975.00
MDXTBL6642REC	66"W x 42"D x 26-40"H Adjustable Height Table	3,150.00
MDXTBL6648REC	66"W x 48"D x 26-40"H Adjustable Height Table	3,325.00

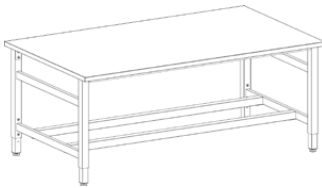

72"W Rectangular Table

Model	Description	List Price
MDXTBL7224REC	72"W x 24"D x 26-40"H Adjustable Height Table	2,700.00
MDXTBL7230REC	72"W x 30"D x 26-40"H Adjustable Height Table	2,875.00
MDXTBL7236REC	72"W x 36"D x 26-40"H Adjustable Height Table	3,050.00
MDXTBL7242REC	72"W x 42"D x 26-40"H Adjustable Height Table	3,225.00
MDXTBL7248REC	72"W x 48"D x 26-40"H Adjustable Height Table	3,400.00

78"W Rectangular Table

Model	Description	List Price
MDXTBL7824REC	78"W x 24"D x 26-40"H Adjustable Height Table	2,810.00
MDXTBL7830REC	78"W x 30"D x 26-40"H Adjustable Height Table	2,985.00
MDXTBL7836REC	78"W x 36"D x 26-40"H Adjustable Height Table	3,160.00
MDXTBL7842REC	78"W x 42"D x 26-40"H Adjustable Height Table	3,335.00
MDXTBL7848REC	78"W x 48"D x 26-40"H Adjustable Height Table	3,510.00

84"W Rectangular Table

Model	Description	List Price
MDXTBL8424REC	84"W x 24"D x 26-40"H Adjustable Height Table	2,885.00
MDXTBL8430REC	84"W x 30"D x 26-40"H Adjustable Height Table	3,060.00
MDXTBL8436REC	84"W x 36"D x 26-40"H Adjustable Height Table	3,235.00
MDXTBL8442REC	84"W x 42"D x 26-40"H Adjustable Height Table	3,410.00
MDXTBL8448REC	84"W x 48"D x 26-40"H Adjustable Height Table	3,585.00

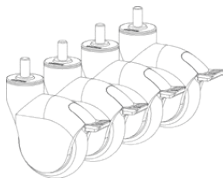

Caster Kit

Model	Description	List Price
CASKIT4	Caster Kit - Set of 4	375.00

Modix Table Shelf Feature

Flexible Shelf Options: A single shelf extends half the length of the table and can easily slide along the footbars, allowing for customizable placement. For those seeking full coverage, two shelves are available, providing versatile solutions tailored to your needs. Simply order two shelves for complete coverage.

- Powder coated steel lower shelves fit on 36", 42" and 48"D tables only.
- Shelves are non-handed.

Model	Type	Width	Depth	Shape	Color
MDX - Modix	TSH - Table Shelf	22 25 28 31 34 37 40	19	REC - Rectangle	See page 35
Example: M D X +	T S H +	3 7 +	1 9 +	R E C +	B L C K
Model Number					Configured Options

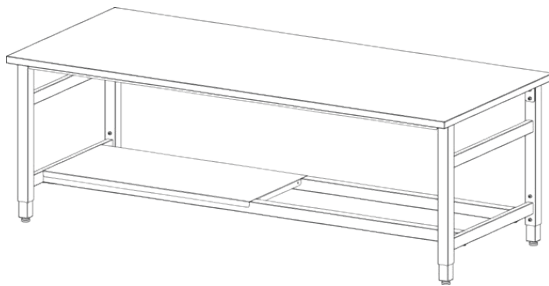

Half (1 Shelf)

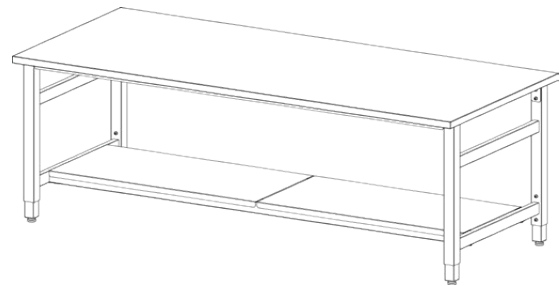

Full (2 Shelves)

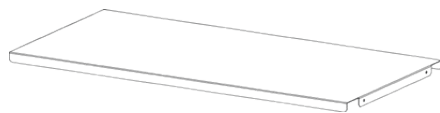

Table Shelf

Model	Description	List Price
MDXTSH2219REC	22"W x 19"D Table Shelf (Fits 48"W x 36, 42, or 48"D Table)	365.00
MDXTSH2519REC	25"W x 19"D Table Shelf (Fits 54"W x 36, 42, or 48"D Table)	375.00
MDXTSH2819REC	28"W x 19"D Table Shelf (Fits 60"W x 36, 42, or 48"D Table)	385.00
MDXTSH3119REC	31"W x 19"D Table Shelf (Fits 66"W x 36, 42, or 48"D Table)	395.00
MDXTSH3419REC	34"W x 19"D Table Shelf (Fits 72"W x 36, 42, or 48"D Table)	405.00
MDXTSH3719REC	37"W x 19"D Table Shelf (Fits 78"W x 36, 42, or 48"D Table)	415.00
MDXTSH4019REC	40"W x 19"D Table Shelf (Fits 84"W x 36, 42, or 48"D Table)	425.00

Modix Upper Frame Features

The upper frame design provides convenient support for hanging accessories above the work surface. Securely attached to the desk base, the fixed-height frame adjusts seamlessly with the desk, ensuring your essentials are always within reach.

- Each upper frame includes one stationary top bar and two configurable mounting bars, providing ample support for shelves, storage, and other accessories
- Upper frames are specifically designed to attach to Modix desks, with widths that correspond to the desk widths.
- Additional mounting bars can be purchased to expand your mounting options:
 37"H upper frame can accommodate up to 2 additional bars (6 total including top bar)
 25"H upper frame can accommodate up to 1 additional bar (4 total including top bar)
- The horizontal design allows users to easily relocate and slide accessories along the mounting bar, giving you the flexibility to customize your workstation to perfectly fit your needs.
- The upper frames are crafted from 14-gauge powder-coated steel, this construction ensures exceptional strength and durability.
- Mounting bars are crafted from durable 16-gauge powder-coated steel.

Upper Frame

Model	Type	Width	Height	Color Options
MDX - Modix	UFR - Upper Frame	36 42 48 54 60 66 72	25 37	See page 35
Example: M D X +	U F R +	4 2 +	2 5 +	J Y O R
Model Number			Configured Options	

Mounting Bar

Model	Type	Width	Color Options
MDX - Modix	UMB - Upper Frame Mounting Bar	36 42 48 54 60 66 72	See page 35
Example: M D X +	U M B +	4 8 +	J Y O R
Model Number		Configured Options	



25"H Upper Frame

Model	Description	List Price
MDXUFR3625	36"W x 25"H Upper Frame	1,107.00
MDXUFR4225	42"W x 25"H Upper Frame	1,258.00
MDXUFR4825	48"W x 25"H Upper Frame	1,408.00
MDXUFR5425	54"W x 25"H Upper Frame	1,480.00
MDXUFR6025	60"W x 25"H Upper Frame	1,552.00
MDXUFR6625	66"W x 25"H Upper Frame	1,632.00
MDXUFR7225	72"W x 25"H Upper Frame	1,714.00

37"H Upper Frame

Model	Description	List Price
MDXUFR3637	36"W x 37"H Upper Frame	1,221.00
MDXUFR4237	42"W x 37"H Upper Frame	1,371.00
MDXUFR4837	48"W x 37"H Upper Frame	1,520.00
MDXUFR5437	54"W x 37"H Upper Frame	1,617.00
MDXUFR6037	60"W x 37"H Upper Frame	1,714.00
MDXUFR6637	66"W x 37"H Upper Frame	1,790.00
MDXUFR7237	72"W x 37"H Upper Frame	1,867.00

Additional Mounting Bars

Model	Description	List Price
MDXUMB36	36"W Upper Frame Mounting Bar	540.00
MDXUMB42	42"W Upper Frame Mounting Bar	575.00
MDXUMB48	48"W Upper Frame Mounting Bar	610.00
MDXUMB54	54"W Upper Frame Mounting Bar	645.00
MDXUMB60	60"W Upper Frame Mounting Bar	680.00
MDXUMB66	66"W Upper Frame Mounting Bar	715.00
MDXUMB72	72"W Upper Frame Mounting Bar	750.00



Modix Upper Shelf Features

Upper shelves offer versatile storage solutions and are specifically designed to attach to the horizontal mounting bars of the upper frame structure. Depending on the shelf size, they can easily slide along the mounting bar or occupy the full length of the bar for maximum utilization.

- Available in durable high-pressure laminate (HPL) for added resilience.

Model	Type	Width	Depth	Bracket Color	Shelf Material	Shelf Color/Pattern
MDX - Modix	USF - Upper Shelf	24 30 36 42 48 54 60 66 72	13 18	See page 35	LAM - Laminate	See page 35
Example: <u>M</u> <u>D</u> <u>X</u> +	<u>U</u> <u>S</u> <u>F</u> +	<u>4</u> <u>2</u> +	<u>1</u> <u>3</u> +	<u>S</u> <u>D</u> <u>B</u> <u>E</u> +	<u>L</u> <u>A</u> <u>M</u> +	<u>L</u> <u>D</u> <u>M</u> <u>K</u>
Model Number				Configured Options		

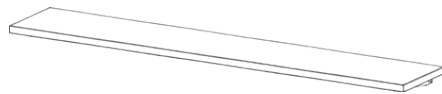

13"D Upper Shelves

Model	Description	List Price
MDXUSF2413	24"W x 13"D Upper Shelf	964.00
MDXUSF3013	30"W x 13"D Upper Shelf	998.00
MDXUSF3613	36"W x 13"D Upper Shelf	1,017.00
MDXUSF4213	42"W x 13"D Upper Shelf	1,043.00
MDXUSF4813	48"W x 13"D Upper Shelf	1,069.00
MDXUSF5413	54"W x 13"D Upper Shelf	1,132.00
MDXUSF6013	60"W x 13"D Upper Shelf	1,194.00
MDXUSF6613	66"W x 13"D Upper Shelf	1,253.00
MDXUSF7213	72"W x 13"D Upper Shelf	1,312.00

18"D Upper Shelves

Model	Description	List Price
MDXUSF2418	24"W x 18"D Upper Shelf	1,295.00
MDXUSF3018	30"W x 18"D Upper Shelf	1,337.00
MDXUSF3618	36"W x 18"D Upper Shelf	1,384.00
MDXUSF4218	42"W x 18"D Upper Shelf	1,405.00
MDXUSF4818	48"W x 18"D Upper Shelf	1,427.00
MDXUSF5418	54"W x 18"D Upper Shelf	1,507.00
MDXUSF6018	60"W x 18"D Upper Shelf	1,587.00
MDXUSF6618	66"W x 18"D Upper Shelf	1,668.00
MDXUSF7218	72"W x 18"D Upper Shelf	1,745.00

Modix Overhead Cabinet Features

Upper storage cabinets deliver flexible and efficient storage solutions, thoughtfully designed to securely attach to the horizontal mounting bars of the upper frame structure. Their innovative design allows for effortless sliding along the mounting bar, enabling seamless customization to suit individual preferences and optimize space.

- Available with robust laminate door fronts and a range of pull options to complement any aesthetic. Please refer to the chart below to select the preferred pull style.

Model	Type 1	Type 2	Width	Depth	Height	Cabinet Paint Color	Door Material	Door Laminate Color	Lock Type	Pull Type
MDX - Modix	OHC - Overhead Cabinet	DD - Double Door	24 30 36	13	16	See page 35	LAM - Laminate	See page 35	KD - Keyed Different KA - Keyed Alike NL - No Lock	1B - Bar Black 1S - Bar Silver 2B - Loop Black 2S - Loop Silver 3B - Square Black 3S - Square Silver 4B - Arch Black 4S - Arch Silver
Example: M D X +	O H C +	D D +	2 4 +	1 3 +	1 6 +	B L C K +	L A M +	P N W N +	N L +	1 B
Model Number						Configured Options				

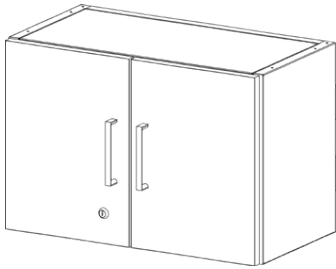

Overhead Storage Cabinet

Model	Description	List Price
MDXOHCDD241316	24"W x 13"D x 16"H Overhead Storage Cabinet	1,531.00
MDXOHCDD301316	30"W x 13"D x 16"H Overhead Storage Cabinet	1,635.00
MDXOHCDD361316	36"W x 13"D x 16"H Overhead Storage Cabinet	1,725.00

1B - Bar Black 1S - Bar Silver	2B - Loop Black 2S - Loop Silver	3B - Square Black 3S - Square Silver	4B - Arch Black 4S - Arch Silver



PWR110V



PWRUSBAC

Model	Description	Color	List Price
PWR110VBL	Single Power Outlet	Black	165.00
PWR110VWH	Single Power Outlet	White	165.00
PWRUSBACBL	(1) USB-A/(1) USB-C Port	Black	513.00
PWRUSBACWH	(1) USB-A/(1) USB-C Port	White	513.00
PWREDCBL	NEW (2) 110V, (1) USB-A, (1) USB-C, Clamp Mount	Black	644.00
PWREDCWH	NEW (2) 110V, (1) USB-A, (1) USB-C, Clamp Mount	White	644.00
PWRISBL	NEW (2) 110V, (2) USB-A, (2) USB-C, Wall plug-In	Black	1,018.00
PWRISWH	NEW (2) 110V, (2) USB-A, (2) USB-C, Wall Plug-In	White	1,018.00
PWRISDCBL	NEW (2) 110V, (2) USB-A, (2) USB-C, Daisy Chain, 60"	Black	1,041.00
PWRISDCWH	NEW (2) 110V, (2) USB-A, (2) USB-C, Daisy Chain, 60"	White	1,041.00
PWRDCSL	NEW Daisy Chain Starter Link (Required to start chain)		1,122.00
PWREXT	NEW Daisy Chain Extension, 12"		157.00

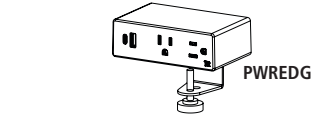

PWREDG

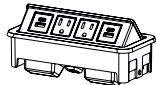

PWRIS

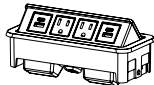

PWRISDC

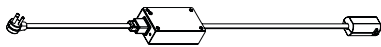

PWRDCSL

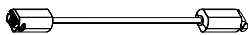

PWREXT

For tables greater than 60" in length:

Connect up to 8 Daisy Chain Power/Data Modules (PWRISDC) plus 12" Extension(s) (PWREXT) to each Daisy Chain Power Infeed (PWRDCSL)

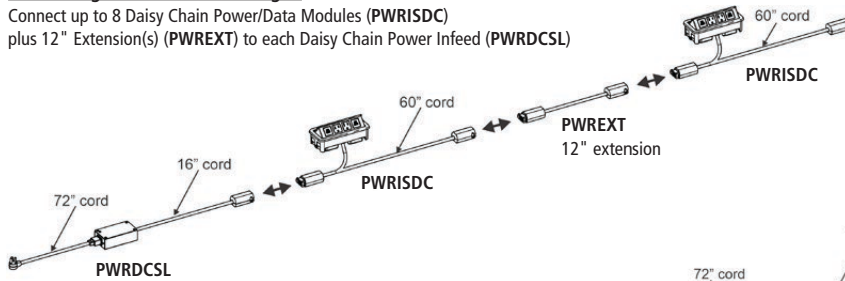

For tables 60" or shorter in length:

Connect up to 8 Daisy Chain Power/Data Modules (PWRISDC) to each Daisy Chain Power Infeed (PWRDCSL)

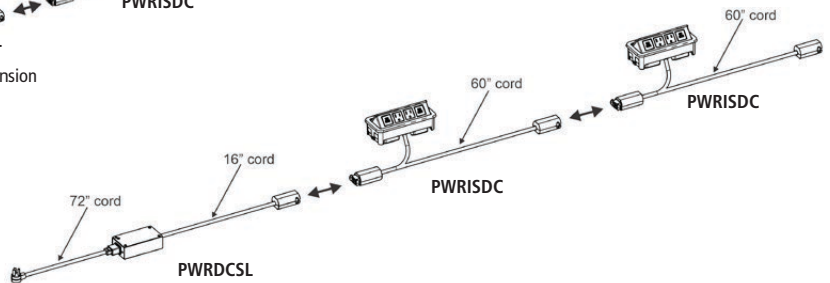

Index

Model No.	Page	Model No.	Page	Model No.	Page	Model No.	Page
ACCSEWH	27	AKDFXT7230REC	21	MDXDSK3630REC	36	MDXUFR3637	42
ACZ4LGP	12	AKDXBB36RND	23	MDXDSK3636REC	36	MDXUFR4225	42
ACZ4LGU	12	AKDXBB36SQR	23	MDXDSK4224REC	36	MDXUFR4237	42
ACZBSTP	14	AKDXBB42RND	23	MDXDSK4230REC	36	MDXUFR4825	42
ACZBSTU	14	AKDXBB42SQR	23	MDXDSK4236REC	36	MDXUFR4837	42
ACZECHP	14	AKDXBS36RND	23	MDXDSK4824REC	37	MDXUFR5425	42
ACZECHU	14	AKDXBS36SQR	23	MDXDSK4830REC	37	MDXUFR5437	42
ACZGCHP	13	AKDXBS42RND	23	MDXDSK4836REC	37	MDXUFR6025	42
ACZGCHU	13	AKDXBS42SQR	23	MDXDSK5424REC	37	MDXUFR6037	42
ACZSLDP	12	ATDHDRMOWHWH	33	MDXDSK5430REC	37	MDXUFR6625	42
ACZSLDU	12	ATDVRMOWHWH	33	MDXDSK5436REC	37	MDXUFR6637	42
ACZTCHP	13	CASKIT4	37, 40	MDXDSK6624REC	37	MDXUFR7225	42
ACZTCHU	13	COHTCHUBL	18	MDXDSK6630REC	37	MDXUFR7237	42
ACZTSTP	13	COHTCHUBU	18	MDXDSK6636REC	37	MDXUMB36	42
ACZTSTU	13	COHTCHUGR	18	MDXDSK7224REC	37	MDXUMB42	42
AKDDBB36RND	23	CRTSLDSL	27	MDXDSK7230REC	37	MDXUMB48	42
AKDDBB36SQR	23	DXDSK6024REC	37	MDXDSK7236REC	37	MDXUMB54	42
AKDDBB42RND	23	DXDSK6030REC	37	MDXOHCDD241316	44	MDXUMB60	42
AKDDBB42SQR	23	DXDSK6036REC	37	MDXOHCDD301316	44	MDXUMB66	42
AKDDBS36RND	23	ECLGCHU	17	MDXOHCDD361316	44	MDXUMB72	42
AKDDBS36SQR	23	ECLMCHU	17	MDXRTN3618REC	38	MDXUSF2412	43
AKDDBS42RND	23	ECLTCHU	16	MDXRTN3624REC	38	MDXUSF2418	43
AKDDBS42SQR	23	ECLMSTU	17	MDXRTN4218REC	38	MDXUSF3012	43
AKDFLP4818REC	21	FDS1636	29	MDXRTN4224REC	38	MDXUSF3018	43
AKDFLP4824REC	21	FDS1648	29	MDXTBL 7830REC	40	MDXUSF3612	43
AKDFLP4830REC	21	FDS1660	29	MDXTBL4824REC	39	MDXUSF3618	43
AKDFLP5418REC	21	FDS1672	29	MDXTBL4830REC	39	MDXUSF4212	43
AKDFLP5424REC	21	FRSVERTPBBL	33	MDXTBL4836REC	39	MDXUSF4218	43
AKDFLP5430REC	21	FRSVERTPBWH	33	MDXTBL4842REC	39	MDXUSF4812	43
AKDFLP6018REC	21	FSDCN3672	28	MDXTBL4848REC	39	MDXUSF4818	43
AKDFLP6024REC	21	FSDCN3684	28	MDXTBL5424REC	39	MDXUSF5412	43
AKDFLP6030REC	21	FSDCN4872	28	MDXTBL5430REC	39	MDXUSF5418	43
AKDFLP6618REC	21	FSDCN4884	28	MDXTBL5436REC	39	MDXUSF6012	43
AKDFLP6624REC	21	FSDMB3672	28	MDXTBL5442REC	39	MDXUSF6018	43
AKDFLP6630REC	21	FSDMB3684	28	MDXTBL5448REC	39	MDXUSF6612	43
AKDFLP7218REC	21	FSDMB4872	28	MDXTBL6024REC	40	MDXUSF6618	43
AKDFLP7224REC	21	FSDMB4884	28	MDXTBL6030REC	40	MDXUSF7212	43
AKDFLP7230REC	21	FSDMX3672	28	MDXTBL6036REC	40	MDXUSF7218	43
AKDFXP4818REC	22	FSDMX3684	28	MDXTBL6042REC	40	MOBCARTWLWH	33
AKDFXP4824REC	22	FSDMX4872	28	MDXTBL6048REC	40	MRJL1AU	19
AKDFXP4830REC	22	FSDMX4884	28	MDXTBL630REC	40	MRJL1BU	19
AKDFXP5418REC	22	FSDSD3672	28	MDXTBL648REC	40	MRJL1LU	19
AKDFXP5424REC	22	FSDSD3684	28	MDXTBL6624REC	40	MRJL1OU	19
AKDFXP5430REC	22	FSDSD4872	28	MDXTBL6636REC	40	MRJL1RU	19
AKDFXP6018REC	22	FSDSD4884	28	MDXTBL6642REC	40	MRJL1TU	19
AKDFXP6024REC	22	IDYERAGR	27	MDXTBL7 230REC	40	Replacement Keys	32
AKDFXP6030REC	22	IDYWB3654SL	27	MDXTBL7 236REC	40	SPHRSCWH	33
AKDFXP6618REC	22	IDYWB3666SL	27	MDXTBL7 824REC	40	STRHRDSL	34
AKDFXP6624REC	22	IDYWB4254SL	27	MDXTBL7 836REC	40	STRHRDWH	34
AKDFXP6630REC	22	IDYWB4266SL	27	MDXTBL7 842REC	40	STRRECSL	34
AKDFXP7218REC	22	JBEAFB6020REC	25	MDXTBL7 848REC	40	STRRECWH	34
AKDFXP7224REC	22	JBEAFB6024REC	25	MDXTBL7224REC	40	UNY01	31
AKDFXP7230REC	22	JBEAFB7220REC	25	MDXTBL7242REC	40	UNY06	32
AKDFXT4818REC	21	JBEAFB7224REC	25	MDXTBL7248REC	40	UNY08	32
AKDFXT4824REC	21	KVGBAR24RNDMPIBU	26	MDXTBL8424REC	40	UNY10	32
AKDFXT4830REC	21	KVGBAR24RNDWLGN	26	MDXTBL8430REC	40	UNY11	32
AKDFXT5418REC	21	KVGBAR24RNDWLWH	26	MDXTBL8436REC	40	UNYLOCFS18	31
AKDFXT5424REC	21	KVGC0F30RNDMPIBU	26	MDXTBL8442REC	40	UNYLOCFS36	31
AKDFXT5430REC	21	KVGC0F30RNDWLGN	26	MDXTBL8448REC	40	UNYTKC	32
AKDFXT6018REC	21	KVGC0F30RNDWLWH	26	MDXTSH2219REC	41	VYBLOCSUGRNTWH	33
AKDFXT6024REC	21	KVGEND22RNDMPIBU	26	MDXTSH2519REC	41	VYBLOCSUGRPTBL	33
AKDFXT6030REC	21	KVGEND22RNDWLGN	26	MDXTSH2819REC	41	WELPRUBL	18
AKDFXT6618REC	21	KVGEND22RNDWLWH	26	MDXTSH3119REC	41	WELPRSUBU	18
AKDFXT6624REC	21	LULDLPL	27	MDXTSH3419REC	41	WELPRSUGN	18
AKDFXT6630REC	21	LULDLPSL	27	MDXTSH3719REC	41	WELPRSUGR	18
AKDFXT7218REC	21	LULDLPTH	27	MDXTSH4019REC	41		
AKDFXT7224REC	21	MDXDSK3624REC	36	MDXUFR3625	42		

