

on
se
mple
le™



General Information

Freight Policy	4	Warranty Statement	9
Customer's Own Material Program	5-6	Quality Statement	10
Non-Standard Laminate (HPL) Program	7-8	Chair Features & Adjustments	11

Seating

Stack

Arcozi Four-Leg.	12
Arcozi Sled	12
Arcozi Bistro-Height	14

Guest

Arcozi Guest	13
Enclude Guest	17

Task

Arcozi Task	13
Arcozi Classroom.	14
Enclude Basic Task.	16
Enclude Deluxe Task	16
Cohere	18

Conference

Enclude Conference.	17
-----------------------------	----

Stools

Arcozi Task Stool	13
Arcozi Bistro-Height	14
Enclude Multi-Purpose Stool	17
Welle.	18

Lounge

Murj.	19
---------------	----

Tables

Multi-Purpose

Akord	21
Jibe	25

Flip & Nest

Akord Flip.	21
---------------------	----

Conference

Akord Conference.	23
---------------------------	----

Cafe

Akord	23
-----------------	----

Bar & Bistro

Jibe	25
----------------	----

Occasional

Konverg	26
-------------------	----

Specialty

Unyon.	30-32
Modix	35-36

Table Accessories

Cord Management	24
Desk Screen	24
Modesty Panel	24
Power	24

Workstations

Desks

Akord	22
Modix	35-36

Storage

Vybe	33
------------	----

Accessories

Modesty Panel	24
Accend Monitor Lift	27
Desk Screen	29
Peg Board	33

Storage

Personal

Atytude	33
Mobee	33
Sphyr	33
Vybe	33

Communal

Unyon	30-32
-------------	-------

Ancillary

Screens

Floor Screens	28
Desk Screens	29

Whiteboards

Idya	27
------------	----

Organization

Peg Board	33
-----------------	----

Lighting

Lulli	27
-------------	----

Power

ConnecTrac	24
Table	24

Ergonomics

Accend	27
--------------	----

Seating

Mobile Chair Cart	27
-------------------------	----

Waste & Recycling

Stream	34
--------------	----

EFFECTIVE JANUARY 3, 2022

Prepaid on all orders of \$1,500 Net or more.

Orders less than \$1,500 Net:

LTL: \$150 Flat rate

Small Parcel: \$25 Flat rate

Orders containing both LTL and small parcel: \$150 flat rate

MINIMUM ORDERS

No minimum order requirement, however, all orders must be placed in full carton quantities.

Special routing request fees for LTL (Accessorial Charges):

- Call before Delivery – Included. Please specify at order entry.
- Lift Gate Assistance – \$125 for orders requiring a lift gate (no loading dock).
- Inside Delivery – \$50 for delivery to threshold only of first door.
 - Does not include put in place, un-carton, assembly, or trash removal.
 - Local restrictions may apply.
- Additional redelivery or storage charges may apply if special routing requests are not specified ahead of time and additional trips are required.
- Contact Customer Service at info@onsemblesolutions.com for a quote on Expedited Service (guaranteed date and time of delivery), or larger volume orders or special services requested over 2,000 lbs. Onsemble is not responsible for issues or costs arising from carrier transit delays, missed delivery appointments, etc.

Freight Damage

All shipments must be carefully inspected upon receipt by the assigned freight forwarder to ensure all items are in satisfactory condition before signing the bill of lading. If there is visible damage or shortage, it must be noted on the bill of lading. If not noted, we will be unable to file a claim with the carrier due to their policies. Visible damage or shortage must be reported within 24 hours of receipt of goods by the freight forwarder.

ORDERING INSTRUCTIONS

For inquiries regarding the specification of COM materials applied to Onsemble made to order seating solutions, contact (info@onsemblesolutions.com).

Step 1: Retrieve the necessary Onsemble made-to-order seating COM form found on page 5.

Step 2: Along with a copy of the COM form, send a 12"x12" material sample to:

909 4th St.

Milford IA, 51351.

Attention COM Receiving

Please include the model number and quantity of products required. This will allow for accurate yardage estimates.

Step 3: Upon approval of the material, please order the appropriate yardage and ship to:

909 4th St.

Milford IA, 51351.

Attention COM Receiving

Ensure the Onsemble purchase order number is included with the ship to address.

Step 4: Purchase orders will be acknowledged with production ship date.

THINGS TO KNOW

- All COM fabrics and vinyls must be approved by Onsemble and will not be scheduled for production until the entire yardage/square footage requirements have been received within the manufacturing facility.
- The COM approval process requires two business days to evaluate and process the 12"x12" material sample.
- Onsemble will not return excessive material. After 60 days from when the production order ships, any excess material will be recycled as part of our continued commitment to protecting the environment.
- Yardage requirements may vary based on several factors including:
Applied fabric direction, size, and geometry of the Onsemble product, and scale or print pattern. Yardage requirements will be conveyed to you upon approval of the 12"x12" sample. It is important to provide the product model number and units within the COM submission form. Yardage calculations are based on 54" wide materials.
- There are no minimum product unit requirements or pricing upcharges. Production lead-times vary by product. Standard warranty provisions apply.

Customer's Own Material Program – Approval Form

CUSTOMER & PRODUCT INFORMATION

Date		Customer Account Number	
Dealer Name		Purchase Order Number	
Dealer Contact		Onsemble Order Number, if available	
Street Address		Onsemble Product Model Number	
City, State, Zip Code		Onsemble Product Quantity (units)	
Phone Number			

TEXTILE INFORMATION

Mill		APPLICATION	
Fabric Color		Is there a desired top/bottom to the fabric? (YES/NO)	
Fabric Name/Number		Is the fabric a stripe or 2-color plaid? (YES/NO)	
Total Yardage Shipped			

TEXTILE ORIENTATION

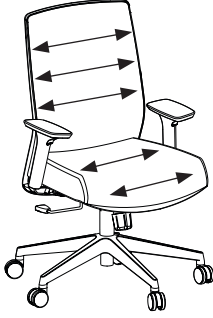
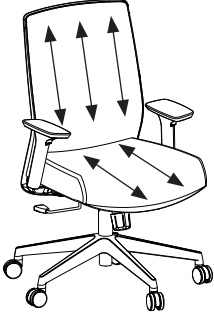
<p>Horizontal</p> <input type="checkbox"/>		<p>Vertical</p> <input type="checkbox"/>	
--	---	--	--

Our Non-Standard Laminate Program offers you the opportunity for us to cater to your laminate needs beyond our standard program.

ORDERING INSTRUCTIONS

Step 1: Retrieve the necessary NSL form for specifying and placing orders from the next page.

Step 2: Complete the form with as much detail as possible and submit it to info@onsemblesolutions.com.

Step 3: We will review your submission within 5 business days and respond promptly with final list pricing.

Step 4: Purchase orders will be acknowledged and the production ship date will be provided.

THINGS TO KNOW

- Non-standard laminate lead times typically range from 6-8 weeks, contingent on the HPL manufacturer and laminate availability.
- Onsemble will procure the specified and approved laminate in the required quantity of sheets to fulfill your project requirements.
- Due to standard laminate sheet sizes, laminates will be applied in a horizontal orientation unless otherwise specified.
- A \$75 net per table upcharge applies to Onsemble non-standard laminates.
- For non-standard laminate upcharges for 20 tables or more, and HPL laminates with special finishes or coatings, please contact info@onsemblesolutions.com.
- If you have any inquiries regarding special non-standard laminates, please email info@onsemblesolutions.com.

Non-Standard Laminate (HPL) Program - Request Form

Return the completed form to info@onsemblesolutions.com

CUSTOMER & PROJECT INFORMATION

Date		Dealer Email	
Dealer Name		Customer Account No.	
Dealer Contact		Project Name	
Street Address		Install Date	
City, State, Zip Code		On-going Standards Program? Yes/No	
Phone Number			

PRODUCT INFORMATION

Onsemble Model/Series Name	
Onsemble Model/Series Number(s)	
Quantity Requested	

LAMINATE INFORMATION

Laminate Manufacturer	
Laminate Name	
Laminate Number	
Edge Band Name	
Edge Band Number	

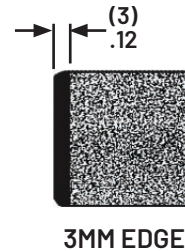

Edge Band Options

- Black (F756)
- Designer Whiter (F582)
- Ice Gray (F755)
- Warm Gray (F754)
- Taupe (F753)
- Silver (F791)
- Medium Brown (F849)
- Dark Brown (F850)
- Raven-Charcoal (F851)
- Brick (F858)
- Other:

ADDITIONAL PROJECT NOTES

1. Due to standard laminate sheet sizes, laminates will need to be applied in a horizontal orientation unless specified.
2. Onsemble non-standard laminates have a \$75 net per table up-charge.
3. Email info@onsemblesolutions.com for non-standard laminate up-charges for 20 tables or more, and HPL laminates with special finishes.
4. For any questions about this form email info@onsemblesolutions.com.

Our warranty pledges excellence in the quality of our products. It helps protect our customer's investments and extends our continuing dedication to our customers after their initial investment.

LIMITED LIFETIME WARRANTY

Onsemble® warranty obligation: We pledge to repair or replace, at Onsemble's option, any Onsemble product or component that is defective in material or workmanship for as long as you, the original purchaser, own it. This warranty is subject to the provisions below.

LIABILITY LIMITATIONS

The following listed parts, components and supplies are covered under warranty in accordance with the below schedule following the product purchase date.

Ten Years: Seating controls and cylinders.

Five Years: Glides, casters, polymer-based components, seating upholstery (fabrics and leather), foam, armrests, chrome seating components, user-adjustable work surface mechanisms, laminates and other covering materials, drawer glides, electrical components, cabinets or mobile systems, components that are either moving parts or controls (guides that are in contact with moving parts).

Three Years: Outdoor Products, electrical components and Dry Erase Surfaces.

WARRANTY SUBJECT TO EXCLUSIONS

Exclusions pertaining to this warranty are as follows but are not limited to:

- Normal wear and tear
- Product or product components utilized with the intent to rent or lease
- Freight damages: Onsemble is not liable for any product damages sustained during shipping or handling operations. Onsemble provides specific policies and requirements regarding shipping and handling, and reserves the right to review and address product distribution matters separately.
- Product negligence: A product is not considered defective due to misuse or improper installation. Onsemble products must be installed, used and maintained in accordance with product instructions and warnings.
- Alterations or attachments to the product that were not approved by Onsemble
- All COM Fabric is not covered under this warranty
- All corrugated products or components
- Use of non-multiple shift products for multiple shifts
- Products purchased through a discontinued products promotion/liquidation

Onsemble's warranty obligation is limited to normal use upon receipt of our products.

SEATING USAGE

Normal commercial usage for seating is defined as the equivalent of a single shift, forty (40) hour work week. To the extent that a seating product is used in a manner exceeding this, the applicable warranty period will be reduced in a pro-rata manner.

WARRANTY PROCEDURES

Please follow the warranty procedures described below:

1. Once a defect has been discovered, the original purchaser must contact Onsemble® immediately (within 30 days of defect detection), in writing, with the serial number(s) (if applicable), date code and model number from the product(s) in question.
2. Upon inspection of the product(s), Onsemble® will collect all relevant information necessary for review of the request.
3. Product replacement and replacement parts will be authorized by a Customer Care representative if acknowledged to be necessary under product warranty eligibility conditions.

SPECIFIC LIMITATIONS REGARDING COLOR VARIATIONS, FABRICS AND FINISHES

Natural products have varying grains and colors. Due to such natural variations occurring in materials such as wood and leather, these characteristics are not considered defects. Onsemble does not warrant the color-fastness or matching of colors, grains or textures of such materials. Materials supplied, selected or provided by the customer (COM) are not warranted.

Buyer is responsible for freight to and from factory on all warranty claims. Any description of the goods sold hereunder, including any reference to Buyer's specifications and any description in catalogs, circulars and other written or digital material published by Onsemble is for the sole purpose of identifying goods and shall not create an express or implied warranty that the goods shall conform to such description.

THERE ARE NO OTHER WARRANTIES, AND Onsemble DISCLAIMS ALL IMPLIED WARRANTIES INCLUDING WARRANTIES OF MERCHANTABILITY, FITNESS FOR A PARTICULAR PURPOSE AND FREEDOM FROM PATENT INFRINGEMENT. NO AGENT, EMPLOYEE OR REPRESENTATIVE OF Onsemble HAS ANY AUTHORITY TO BIND Onsemble TO ANY AFFIRMATION, REPRESENTATION OR WARRANTY EXCEPT AS STATED HEREIN.

Onsemble SHALL HAVE NO LIABILITY FOR INDIRECT, INCIDENTAL, CONSEQUENTIAL OR SPECIAL DAMAGES OF ANY KIND. THESE LIMITATIONS ARE AGREED ALLOCATIONS OF RISK. UNDER NO CIRCUMSTANCES SHALL Onsemble'S LIABILITY WITH REGARD TO THE SALE OR USE OF THE PRODUCTS EXCEED THE PURCHASE PRICE PAID BY THE BUYER FOR THE PRODUCTS. TERMS AND CONDITIONS OF THIS WARRANTY ARE SUBJECT TO CHANGE WITHOUT NOTICE.

Note: Onsemble® does not require the customer to fill out a warranty registration card. Please keep all purchase documents for the product in event the warranty is needed. Contact our Customer Care team for any warranty assistance at info@onsembleproducts.com or (877) 835-2935.

STATEMENT OF QUALITY

At Onsemble®, we understand that quality extends beyond simple function, and we are committed to the highest level of satisfaction in the manufacture, sale, and support of our products. From concept to delivery, we integrate high levels of quality as our standard and work hard to impress our customers every day. We strive for continuous improvements in all areas of product and service by regarding our quality programs as an integral part of the company's improvement process. Onsemble's quality program works to provide products that meet or exceed the quality standards our customers expect. We aim to set high environmental and safety standards by offering a large collection of third-party tested products that meet standards set forth by BIFMA, UL, the State of California, and others.

PROP 65 WARNINGS

Products with this icon  are subject to California Proposition 65. Please visit the product detail page on our website for specific information.

ENVIRONMENTAL COMMITMENTS

Onsemble not only holds itself to strict environmental standards, but we also require suppliers to follow these standards as a total supply chain initiative. Suppliers play an important role in our longstanding commitment to perform operations in a manner consistent with sound health, safety, and environmental management practices. Because of this, suppliers are not only expected to comply with applicable health, safety and environmental laws and regulations, they are expected to seek continuous improvement within these realms.

Onsemble continues to become an environmentally conscious company with the intention to offer more products that our customers can feel good about, and responsible practices that encourage sustainability, helping us obtain a proud standing in our community and the planet.

OPERATIONS

Onsemble advocates continuous improvement in the realms of efficient recycling and/or disposal of waste materials and improving treatment and control of waste emissions affecting air, water, and soil. We also encourage the practice of waste reduction operations such as machine efficiency, raw material utilization, conservation of soil, air, water quality, biodiversity, wildlife and aquatic habitats, the practice of sustainable forest management policies where applicable, end-of-life treatment recommendations, raw material and recycled content regulation, and legal compliance with environmental legislation.

DESIGN

We reserve the right to make changes in design and material, as well as discontinuance of parts and units, when such action is deemed to be an improvement in design, function and/or construction.

THE FOLLOWING ICONS ARE USED THROUGHOUT THIS PUBLICATION:





Seat Height Adjustment

Quick and easy adjustment regulates height of chair relative to the floor.



Seat Glide Mechanism

Seat cushion travels forward and back, then locks into position.



Weight Sensitive Mechanism

Adjusts seat and back angles by sensing the user's body weight and reclines accordingly.



Tilt Tension

Controls rate and ease with which chair reclines to different weight and strength of users.



Tilt Lock

Locks tilt function when chair is in upright position.



Asynchronous Control

Three levers modify:

1. Angle of back relative to seat
2. Tilt (free float or infinite locking within a fixed range)
3. Forward tilt (for keyboard intensive applications)

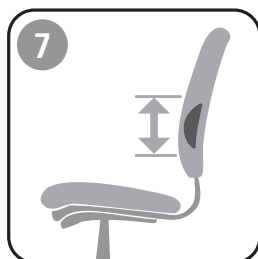

Integral Lumbar Support

Easily adjust to enhance comfort.

There are many features to consider when selecting the perfect chair to suit your needs. The following symbols will help you choose the features that are right for you. These symbols are used throughout this pricer to help quickly identify each chair's features. The descriptions of the features shown are meant to be general explanations. The actual functions of the features may vary slightly between chair series.

Poly Options

Back & Lower Back/Seat Color Options



Shell Color Option Not Available. WH Only.



Frame Options

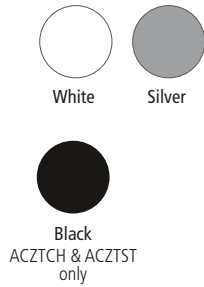

Fabric Options

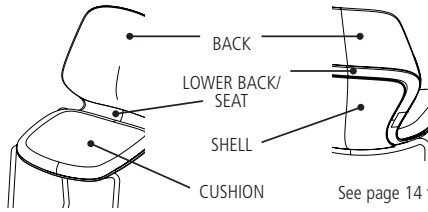

See page 14 for more chair details.

Parent #	Description	Model #	List Price Ea.	List Carton Price	Quantity Per Carton	Actual Weight	S-Parcel Billable Weight	Carton Cube	Freight Class
ACZ4LG	Arcozi 4 Leg Stack Chair All Poly Arcozi 4 Leg Stack Chair Upholstered Seat Height: 19" Chair Overall: 20.75"W x 22.25"D x 34.5"H	ACZ4LGP	433.00	866.00	2	38	123	11.62	250
		ACZ4LGU	572.00	1,144.00	2	38	123	11.62	250
ACZSLD	Arcozi Sled Base Stack Chair All Poly Arcozi Sled Base Stack Chair Upholstered Seat Height: 21" Chair Overall: 21.75"W x 21.75"D x 36.5"H	ACZSLDP	451.00	902.00	2	37.5	123	11.62	250
		ACZSLDU	590.00	1,180.00	2	40	123	11.62	250

Model	Back Color	Seat Color	Upholstered Seat	Frame Color
ACZ4LGP - 4 Leg Stack Poly ACZ4LGU - 4 Leg Stack Uph. ACZSLDP - Sled Base Stack Poly ACZSLDU - Sled Base Stack Uph.	BL - Black BU - Blue GN - Green GR - Gray	RD - Red TP - Taupe WH - White	BL - Black BU - Blue GN - Green GR - Gray	RD - Red TP - Taupe WH - White
			See above for Fabric Options	SL-Silver WH-White
			*for All Poly, leave blank	
Example: ACZ4LGP +	BU +	BU +	OR18 +	SL

Parent # Description Model # List Price

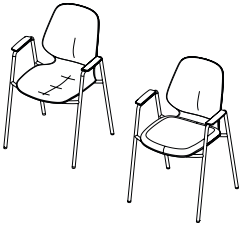

ACZGCH Arcozi Guest Chair All Poly
 Arcozi Guest Chair Upholstered
 Seat Height: 19"
 Chair Overall: 23.25"W x 22.25"D x 34.5"H

ACZGCHP 572.00
 ACZGCHU 712.00

Model	Back Color	Seat Color	Upholstered Seat	Frame Color
ACZGCHP - Arcozi Guest Chair Poly ACZGCHU - Arcozi Guest Chair Uph.	BL - Black BU - Blue GN - Green GR - Gray	RD - Red TP - Taupe WH - White	BL - Black BU - Blue GN - Green GR - Gray	RD - Red TP - Taupe WH - White
			See page page 12 for Fabric Options *for All Poly, leave blank	SL-Silver WH-White
Example: ACZGCHP +	BU +	BU +	OR18 +	SL



ACZTCH Arcozi Task Chair - All Poly
 Arcozi Task Chair - Upholstered
 Seat Height: 17-22"
 Chair Overall: 30.5"W x 30.5"D x 33-38"H

ACZTCHP 746.00
 ACZTCHU 886.00

Upcharge
 Seat Poly Color N/C
 Back Poly Color N/C
 Add Arms 75.00
 Standard Caster N/C
 Hard Floor Caster N/C
 Hard Floor Premium 65.00



ACZTST Arcozi Task Stool - All Poly
 Arcozi Task Stool - Upholstered
 Seat Height: 22.25-32.25"
 Chair Overall: 30.5"W x 30.5"D x 38-48"H

ACZTSTP 903.00
 ACZTSTU 1,042.00

Upcharge
 Seat Poly Color N/C
 Back Poly Color N/C
 Add Arms 75.00
 Standard Caster N/C
 Hard Floor Caster N/C
 Hard Floor Premium 65.00

Model	Back Color	Seat Color	Upholstered Fabric	Arms	Casters	
ACZTCHP - Task Chair Poly ACZTCHU - Task Chair Uph. ACZTSTP - Task Stool Poly ACZTSTU - Task Stool Uph	BL-Black BU-Blue GN-Green GR-Gray	RD-Red TP-Taupe WH-White	BL-Black BU-Blue GN-Green GR-Gray	RD-Red TP-Taupe WH-White	AL-Armless WA-With Arms	ST-Standard Caster HF-Hard Floor HFP-Hard Floor Premium
			See page 12 for Fabric Options *for All Poly, leave blank			
Example: ACZTCHP +	BL +	BU +	OR18 +	AL +	HF	

Parent #	Description	Model #	List Price Ea.	List Carton Price	Quantity Per Carton
----------	-------------	---------	----------------	-------------------	---------------------

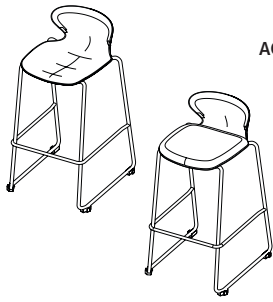

ACZBST Arcozi Bar Height Stool - All Poly
Arcozi Bar Height Stool - Upholstery
 Seat Height: 33"
 Chair Overall: 21.5"W x 24"D x 40.75"H

ACZBSTP 729.00 1,458.00 2
 ACZBSTU 868.00 1,736.00 2

Model	Seat Color	Upholstered Fabric	Frame Color
ACZBSTP - Arcozi Bar Height Chair Poly ACZBSTU - Arcozi Bar Height Chair Uph	BL-Black BU-Blue GN-Green GR-Gray	RD-Red TP-Taupe WH-White	SL-Silver WH-White
		See page 12 for Fabric Options	
		*for All Poly, leave blank	
Example: A C Z B S T P +	B U +	O R 1 8 +	S L

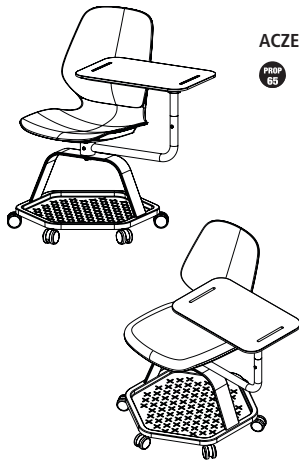

ACZECH Arcozi Education Chair - All Poly
Arcozi Education Chair - Upholstery
 Seat Height: 18.75"
 Chair Overall: 31.5"W x 26"D x 33.75"H

ACZECHP 1,184.00
 ACZECHU 1,321.00

Universal Tablet Arm

Subtract \$75 from price for No Tablet

Model	Back Color	Seat Color	Upholstered Fabric	Frame Color	Casters or Glides	Tablet Choice	Tablet Color	
ACZECHP - Arcozi Education Chair Poly ACZECHU - Arcozi Education Chair Uph.	BL-Black BU-Blue GN-Green GR-Gray	RD-Red TP-Taupe WH-White	BL-Black BU-Blue GN-Green GR-Gray	RD-Red TP-Taupe WH-White	SL-Silver WH-White	CA-Casters GL-Glides	WT-With Tablet NT-No Tablet	BL-Black WH-White
			See page 12 for Fabric Options					
			*for All Poly, leave blank					
Example: A C Z E C H P +	B L +	B U +	O R 1 8 +	S L +	C A +	W T +	B L	

A. Back
B. Lower Back Seat
C. Shell

D. Cushion (optional)
E. Arm Pads
F. Frame

G. Glides
H. Ganging Glides
I. Arms

J. Piston
K. Cylinder
L. Foot Ring

M. 5-Star Base
N. Casters
O. Tablet

P. Tablet Arm with Built-In Drink Holder
Q. Base Shelf

Chair Details

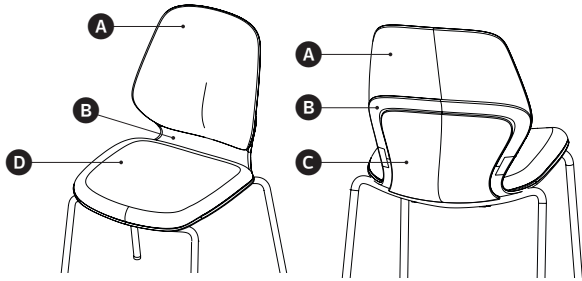

Stack Chair (4-Leg)

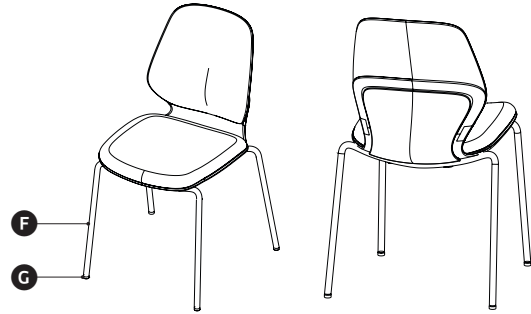

Stack Chair (Sled Base)

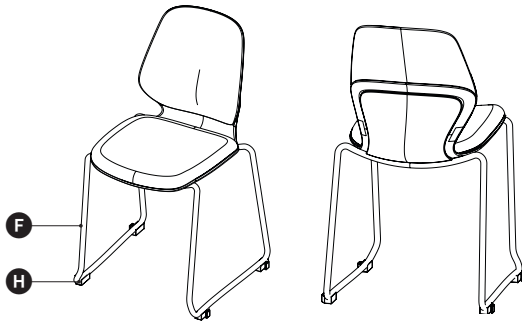

Guest Chair

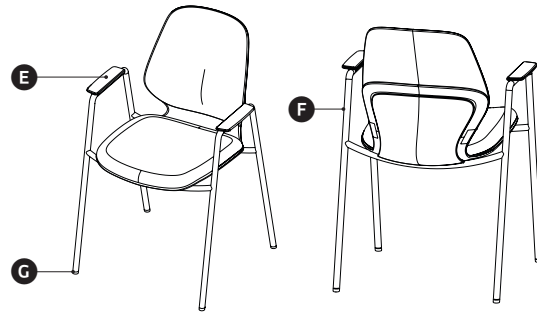

Bistro Chair

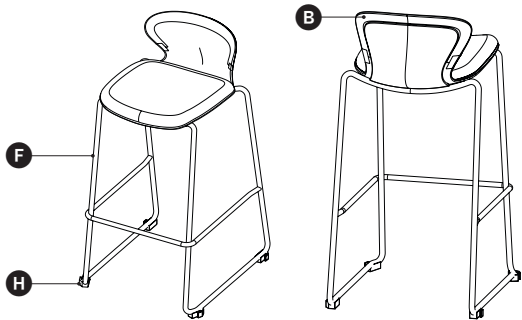

Task Chair

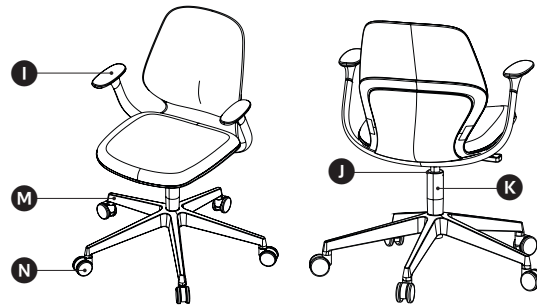

Extended-Height Chair



Education Chair

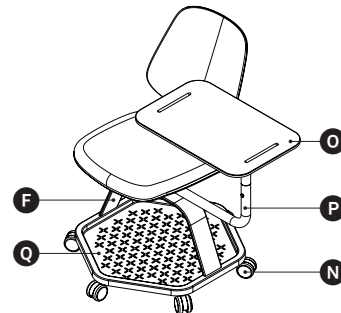

Mesh Options

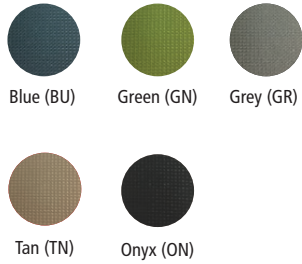

Fabric Options



Parent # Description Model # List Price

ECLTCHU **Enclude Task Chair** **1 2 4 7 ***
 Seat Height: 18" - 22"
 Seat: 18"W x 18"D
 Back: 17.5"W x 18.5"H
 Overall : 25"W x 25"D x 34.5" - 38"H

ECLTCHU 988.00

Upcharge

Basic Mechanism	N/C
Deluxe Mechanism	355.00
Headrest	111.00
Standard Caster	N/C
Hard Floor Caster	N/C
Hard Floor Premium	65.00

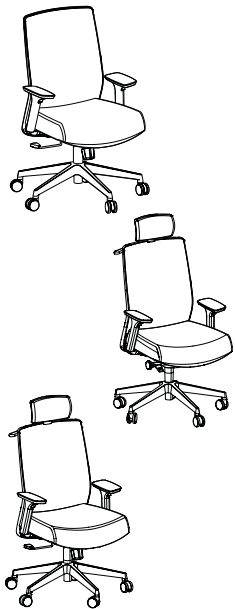

Model	Back Mesh	Seat Fabric	Headrest	Headrest Fabric	Mechanism	Caster Option
ECLTCHU	BU - Blue Mesh GN - Green Mesh GR - Gray Mesh ON - Onyx Mesh TN - Tan Mesh	See above for Fabric Options	N - Without Headrest Y - With Headrest	See above for Fabric Options *for no headrest, leave blank	BM - Basic Mech ST - Deluxe Side-Tension Mech	ST - Standard Carpet HF - Hard Floor HFP - Hard Floor Premium
<u>E</u> <u>C</u> <u>L</u> <u>T</u> <u>C</u> <u>H</u> <u>U</u> +	<u>B</u> <u>U</u> +	<u>O</u> <u>R</u> <u>1</u> <u>3</u> +	<u>Y</u> +	<u>O</u> <u>R</u> <u>1</u> <u>3</u> +	<u>S</u> <u>T</u> +	<u>H</u> <u>F</u> <u>P</u>

Parent # Description Model # List Price Ea. Carton Price Qty. Per Carton



ECLTSTU Enclude Task Stool ¹*
 Seat Height: 23" - 33"
 Seat: 18"W x 18"D
 Back: 18"W x 18"H
 Overall : 28"W x 28"D x 38" - 48"H

Upcharge

Standard Caster N/C
 Hard Floor Caster N/C
 Hard Floor Premium 65.00

Model	Back Mesh	Seat Fabric	Caster Option
ECLTSTU	BU - Blue Mesh GN - Green Mesh GR - Gray Mesh	ON - Onyx Mesh TN - Tan Mesh See page 16 for Fabric Options	ST - Standard Carpet HF - Hard Floor HFP - Hard Floor Premium
Example: E C L T S T U +	B U +	O R 1 3 +	H F P



ECLMCHU Enclude Multi-Purpose Chair ¹*
 Seat Height: 17" - 22"
 Seat: 18"W x 18"D
 Back: 18"W x 18"H
 Overall : 28"W x 28"D x 32" - 37"H

Upcharge

Standard Caster N/C
 Hard Floor Caster N/C
 Hard Floor Premium 65.00

Model	Back Mesh	Seat Fabric	Caster Option
ECLMCHU	BU - Blue Mesh GN - Green Mesh GR - Gray Mesh	ON - Onyx Mesh TN - Tan Mesh See page 16 for Fabric Options	ST - Standard Carpet HF - Hard Floor HFP - Hard Floor Premium
Example: E C L M C H U +	B U +	O R 1 3 +	H F P



ECLGCHU Enclude Guest Chair 2/CTN
 Seat Height: 18"
 Seat: 18"W x 18"D
 Back: 18"W x 18"H
 Overall : 23.5"W x 23.5"D x 33.5"H
 Frame: Black

Upcharge

Standard Caster N/C
 Hard Floor Caster N/C
 Hard Floor Premium 65.00

Model	Back Mesh	Seat Fabric	Caster Option
ECLGCHU	BU - Blue Mesh GN - Green Mesh GR - Gray Mesh	ON - Onyx Mesh TN - Tan Mesh See page 16 for Fabric Options	ST - Standard Carpet HF - Hard Floor HFP - Hard Floor Premium
Example: E C L G C H U +	B U +	O R 1 3 +	H F P

Parent #	Description	Model #	List Price
----------	-------------	---------	------------

Cohere Fabric Options



Black (BL)
Fabric



Blue (BU)
Fabric



Gray (GR)
Fabric



COHTCHU Cohere Task Chair
 Seat Height: 20.75"
 Seat: 19"W x 20"D
 Overall : 27"W x 26"D x 44.5"H
 BL - Black
 BU - Blue
 GR - Gray

COHTCHUBL 1,350.00
 COHTCHUBU
 COHTCHUGR

Welle Fabric & Base Options

Black (BL)



Fabric



Plastic Base

Blue (BU)



Fabric



Plastic Base

Gray (GR)



Fabric



Plastic Base

Green (GN)



Fabric



Plastic Base

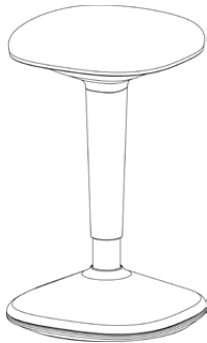

WELPRSU Welle Active Stool
 Seat Height: 22.75"-31.25"
 Overall : 13"W x 13"D x 31.25"H
 BL - Black
 BU - Blue
 GN - Green
 GR - Gray

WELPRSUBL 575.00
 WELPRSUBU
 WELPRSUGN
 WELPRSUGR

Fabric Options



Leg Options



HPL Laminate + Matching Edge Color Option

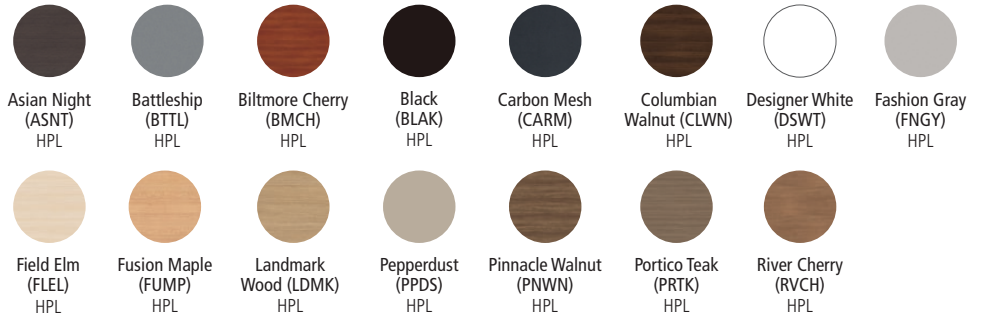

	Parent #	Description	Model #	List Price
	MRJLGBU	Lounge Chair, Both Arms Seat: 24"W x 19"D x 18.5"H Back: 24"W x 15.25"H Arm: 6"H Overall: 30"W x 24"D x 33.75"H	MRJLGBU	1,740.00
	MRJLGRU	Lounge Chair, Right Arm Seat: 24"W x 19"D x 18.5"H Back: 24"W x 15.25"H Arm: 6"H Overall: 27"W x 24"D x 33.75"H	MRJLGRU	1,610.00
	MRJLGLU	Lounge Chair, Left Arm Seat: 24"W x 19"D x 18.5"H Back: 24"W x 15.25"H Arm: 6"H Overall: 27"W x 24"D x 33.75"H	MRJLGLU	1,610.00
	MRJLGAU	Lounge Chair, Armless Seat: 24"W x 19"D x 18.5"H Back: 24"W x 15.25"H Overall: 24"W x 24"D x 33.75"H	MRJLGAU	1,479.00
	MRJLGOU	Lounge Ottoman Overall: 24"W x 24"D x 18.5"	MRJLGOU	1,218.00
	MRJLGTU	Lounge Table Overall: 24"W x 24"D x 16"H	MRJLGTU	1,218.00

SEATING

Model	Fabric
MRJLGBU - Lounge Chair Both Arms MRJLGLU - Lounge Chair Left Arm MRJLGRU - Lounge Chair Right Arm MRJLGAU - Lounge Chair Armless MRJLGOU - Lounge Ottoman	DT08 - Taupe DT15 - Platinum DT16 - Slate
Example: MRJLGBU +	DT08

TABLE

Model	Fabric	Laminate Top
MRJLGTU - Lounge Table	DT08 - Taupe DT15 - Platinum DT16 - Slate	See above for HPL laminate with match 3mm edgeband choices
Example: MRJLGTU +	DT08 +	ASNT

Laminate + Matching Edge Color Option



Base Color Options



Cutout Options



Cutout-F

"F" – \$30 List upcharge

- (1) Manufactured rectangular cutout 6.875 x 3" for daisy chain electrical kits only. See page 26 for available kit options.
- Grommet caps not included with cutout.



Cutout-G

"G" – \$30 List upcharge

- (1) Manufactured round cutout 1.75" in diameter located in center approach side of top.
- Includes black grommet cap.



Cutout-M

"M" – \$60 List upcharge

- (2) Manufactured round cutouts 1.75" diameter located on right and left approach side of top.
- Includes (2) black grommet caps.

Laminate Edge Type

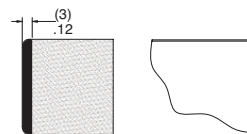

3 MM EDGE BAND

Note: All non-standard cutouts (other than above) will be reviewed to determine if the cutout does not interfere with the base, degrade table strength or cause imbalance. Contact specials@onsemblesolutions.com for quote request and drawing signoff will be required before order is processed.

- A cohesive collection allowing specifiers to achieve a similar look throughout a space
- 1-1/8" thick tops with matching 3mm edge banding
- Tables available in Flip, T-Leg, Post-Leg, Café, Bistro, and Conference
- Flip tables feature dual-sided levers for a quick flip of the top
- Flip tables nest for compact storage

- Sitting-height tables are 29"H
- Bisto café tables are 42"H
- Textured SILVER powder coat bases
- Glide option includes 4 adjustable glides
- Caster options include 4 locking casters
- Manufactured cutouts and power option available

Akord Multi-Purpose Tables

Flip Base Table w/Casters

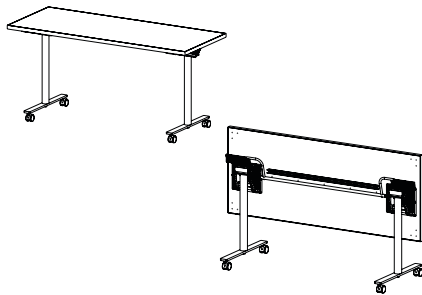

Model	Description	List Price
AKDFLP4818REC	Akord 48"x18" Flip Base	1,862.00
AKDFLP4824REC	Akord 48"x24" Flip Base	1,909.00
AKDFLP4830REC	Akord 48"x30" Flip Base	2,027.00
AKDFLP5418REC	Akord 54"x18" Flip Base	1,891.00
AKDFLP5424REC	Akord 54"x24" Flip Base	1,945.00
AKDFLP5430REC	Akord 54"x30" Flip Base	2,085.00
AKDFLP6018REC	Akord 60"x18" Flip Base	2,008.00
AKDFLP6024REC	Akord 60"x24" Flip Base	2,064.00
AKDFLP6030REC	Akord 60"x30" Flip Base	2,229.00

Model	Description	List Price
AKDFLP6618REC	Akord 66"x18" Flip Base	2,069.00
AKDFLP6624REC	Akord 66"x24" Flip Base	2,123.00
AKDFLP6630REC	Akord 66"x30" Flip Base	2,252.00
AKDFLP7218REC	Akord 72"x18" Flip Base	2,145.00
AKDFLP7224REC	Akord 72"x24" Flip Base	2,212.00
AKDFLP7230REC	Akord 72"x30" Flip Base	2,372.00



Model	Top Width	Top Depth	Top Shape	Leg Color	Power Cut Out	Top Color/Pattern
AKDFLP	48 54 60 66 72	18 24 30	REC - Rectangle	See page 20 for Base Color options	N - None F - Rectangle Cutout (\$30 upcharge) G - Center Rnd Cutout (\$30 upcharge) M - Left/Right Rnd Cutout (\$60 upcharge)	See page 20 for HPL laminate with matching 3mm edgeband choices
AKDFLP+	60+	24+	REC+	GRAY+	F+	ASNT

T-Leg Table

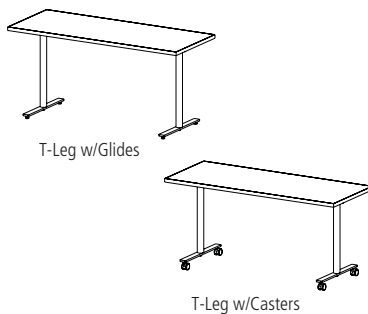

Model	Description	List Price
AKDFXT4818REC	Akord 48"x18" T-Leg	1,432.00
AKDFXT4824REC	Akord 48"x24" T-Leg	1,479.00
AKDFXT4830REC	Akord 48"x30" T-Leg	1,597.00
AKDFXT5418REC	Akord 54"x18" T-Leg	1,462.00
AKDFXT5424REC	Akord 54"x24" T-Leg	1,514.00
AKDFXT5430REC	Akord 54"x30" T-Leg	1,653.00
AKDFXT6018REC	Akord 60"x18" T-Leg	1,563.00
AKDFXT6024REC	Akord 60"x24" T-Leg	1,618.00
AKDFXT6030REC	Akord 60"x30" T-Leg	1,784.00

Model	Description	List Price
AKDFXT6618REC	Akord 66"x18" T-Leg	1,623.00
AKDFXT6624REC	Akord 66"x24" T-Leg	1,677.00
AKDFXT6630REC	Akord 66"x30" T-Leg	1,806.00
AKDFXT7218REC	Akord 72"x18" T-Leg	1,653.00
AKDFXT7224REC	Akord 72"x24" T-Leg	1,721.00
AKDFXT7230REC	Akord 72"x30" T-Leg	1,881.00



Model	Top Width	Top Depth	Top Shape	Casters/Glides	Leg Color	Power Cut Out	Top Color/Pattern
AKDFXT	48 54 60 66 72	18 24 30	REC - Rectangle	CA - Casters GL - Glides	See page 20 for Base Color options	N - None F - Rectangle Cutout G - Center Rnd Cutout M - Left/Right Rnd Cutout	See page 20 for HPL laminate with matching 3mm edgeband choices
AKDFXT+	60+	24+	REC+	CA+	GRAY+	F+	ASNT

Post-Leg Table

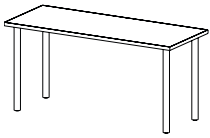

Post-Leg w/Glides

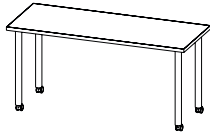

Post-Leg w/Casters

Model	Description	List Price
AKDFXP4818REC	Akord 48"x18" Post Leg	1,277.00
AKDFXP4824REC	Akord 48"x24" Post Leg	1,324.00
AKDFXP4830REC	Akord 48"x30" Post Leg	1,442.00
AKDFXP5418REC	Akord 54"x18" Post Leg	1,307.00
AKDFXP5424REC	Akord 54"x24" Post Leg	1,359.00
AKDFXP5430REC	Akord 54"x30" Post Leg	1,498.00
AKDFXP6018REC	Akord 60"x18" Post Leg	1,408.00
AKDFXP6024REC	Akord 60"x24" Post Leg	1,463.00
AKDFXP6030REC	Akord 60"x30" Post Leg	1,629.00

Model	Description	List Price
AKDFXP6618REC	Akord 66"x18" Post Leg	1,469.00
AKDFXP6624REC	Akord 66"x24" Post Leg	1,523.00
AKDFXP6630REC	Akord 66"x30" Post Leg	1,651.00
AKDFXP7218REC	Akord 72"x18" Post Leg	1,498.00
AKDFXP7224REC	Akord 72"x24" Post Leg	1,564.00
AKDFXP7230REC	Akord 72"x30" Post Leg	1,726.00



Model	Top Width	Top Depth	Top Shape	Casters/Glides	Leg Color	Power Cut Out	Top Color/Pattern
AKDFXP	48 54 60 66 72	18 24 30	REC - Rectangle	CA - Casters GL - Glides	See page 20 for Base Color options	N - None F - Rectangle Cutout G - Center Rnd Cutout M - Left/Right Rnd Cutout	See page 20 for HPL laminates with matching 3mm edgeband choices
AKDFXP+	60+	24+	REC+	CA+	GRAY+	F+	ASNT

X-Base Tables

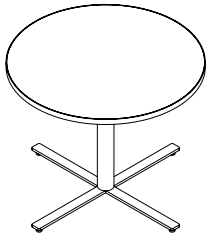

NEW **PROP 65**

Model	Description	List Price
AKDXBB36RND	Akord 36" Round Top, X-Base 42"H	1,608.00
AKDXBB36SQR	Akord 36" Square Top, X-Base 42"H	1,608.00
AKDXBB42RND	Akord 42" Round Top, X-Base 42"H	1,761.00
AKDXBB42SQR	Akord 42" Square Top, X-Base 42"H	1,761.00
AKDXBS36RND	Akord 36" Round Top, X-Base 29"H	1,533.00
AKDXBS36SQR	Akord 36" Square Top, X-Base 29"H	1,533.00
AKDXBS42RND	Akord 42" Round Top, X-Base 29"H	1,688.00
AKDXBS42SQR	Akord 42" Square Top, X-Base 29"H	1,688.00

Model	Top Size	Top Shape	Leg Color	Top Color/Pattern
AKDXBS - Sitting Height AKDXBB - Bar Height	36 42	RND - Round SQR - Square	See page 20 for Base Color options	See page 20 for HPL laminates with matching 3mm edgeband choices
AKDXBS +	36 +	RND +	GRAY +	ASNT

Disc-Base Tables

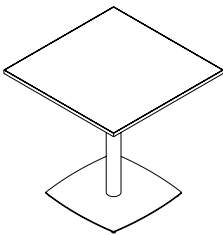

NEW **PROP 65**

Model	Description	List Price
AKDDBB36RND	Akord 36" Round Top, Disc-Base 42"H	1,693.00
AKDDBB36SQR	Akord 36" Square Top, Disc-Base 42"H	1,693.00
AKDDBB42RND	Akord 42" Round Top, Disc-Base 42"H	2,003.00
AKDDBB42SQR	Akord 42" Square Top, Disc-Base 42"H	2,003.00
AKDDBS36RND	Akord 36" Round Top, Disc-Base 29"H	1,620.00
AKDDBS36SQR	Akord 36" Square Top, Disc-Base 29"H	1,620.00
AKDDBS42RND	Akord 42" Round Top, Disc-Base 29"H	1,928.00
AKDDBS42SQR	Akord 42" Square Top, Disc-Base 29"H	1,928.00

Model	Top Size	Top Shape	Leg Color	Top Color/Pattern
AKDDBS - Sitting Height AKDDBB - Bar Height	36 42	RND - Round SQR - Square	See page 20 for Base Color options	See page 20 for HPL laminates with matching 3mm edgeband choices
AKDDBS +	36 +	RND +	GRAY +	ASNT

Conference Tables

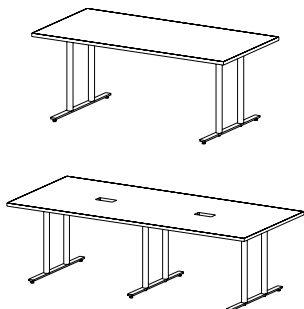

NEW **PROP 65**

Model	Description	List Price
AKDCNF7236REC	Akord 72"x36" Conference 29"H	2,387.00
AKDCNF8442REC	Akord 84"x42" Conference 29"H	2,654.00
AKDCNF9642REC	Akord 96"x42" Conference 29"H	3,537.00

Model	Top Size	Top Shape	Leg Color	Power Cut Out	Top Color/Pattern
AKDCNF	7236 8442 9642	REC - Rectangle	See page 20 for Base Color options	N - None F - Rectangle Cutout G - Center Rnd Cutout M - Left/Right Rnd Cutout	See page 20 for HPL laminates with matching 3mm edgeband choices
AKDCNF +	7 2 3 6 +	REC +	GRAY +	F +	ASNT

Akord Table Collection

AKORD



PWR110V



PWRUSBAC

Model #	Description	Color	List Price
PWR110VBL	Single Power Outlet	Black	165.00
PWR110VWH	Single Power Outlet	White	165.00
PWRUSBACBL	1 USB/1 USBC Port	Black	513.00
PWRUSBACWH	1 USB/1 USBC Port	White	513.00
PWREDGBL	2-110V, 1USB, 1USBC, Clamp Mount	Black	644.00
PWREDGWH	2-110V, 1USB, 1USBC, Clamp Mount	White	644.00
PWRISBL	2-110V, 2USB, 2USBC, Wall plug-In	Black	1,018.00
PWRISWH	2-110V, 2USB, 2USBC, Wall Plug-In	White	1,018.00
PWRISDCBL	2-110V, 2USB, 2USBC, Daisy Chain, 60"	Black	1,041.00
PWRISDCWH	2-110V, 2USB, 2USBC, Daisy Chain, 60"	White	1,041.00

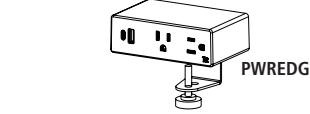

PWREDG

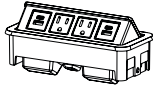

PWRIS

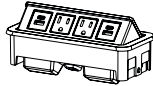

PWRISDC

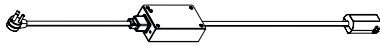

PWRDCSL	Daisy Chain Starter Link (Required to start chain)	-	1,122.00
---------	--	---	----------

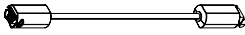

PWREXT	Daisy Chain Extension, 12"	-	157.00
--------	----------------------------	---	--------

For tables greater than 60" in length:

Connect up to 8 Daisy Chain Power/Data Modules (PWRISDC) plus 12" Extension(s) (PWREXT) to each Daisy Chain Power Infeed (PWRDCSL)

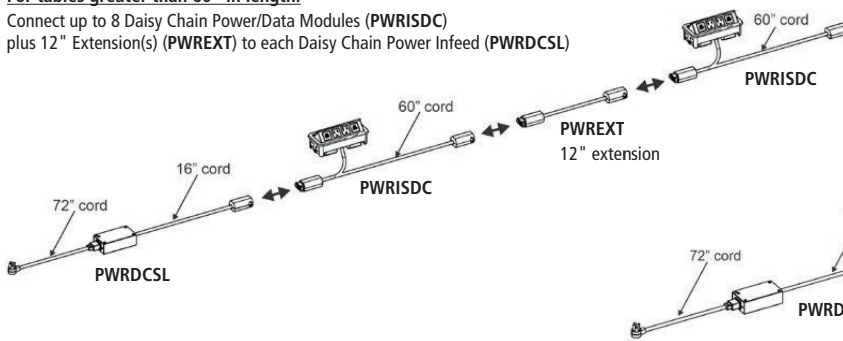

For tables 60" or shorter in length:

Connect up to 8 Daisy Chain Power/Data Modules (PWRISDC) to each Daisy Chain Power Infeed (PWRDCSL)

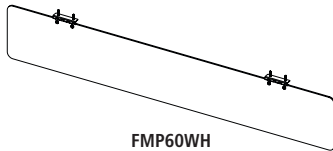
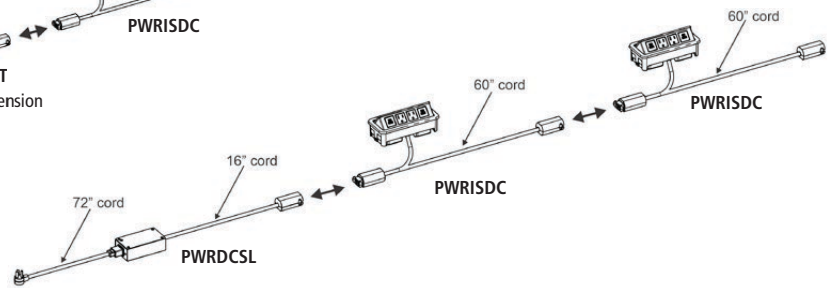

FMP60WH

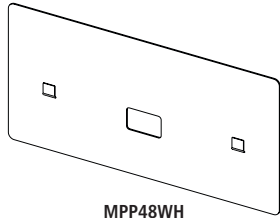

MPP48WH

• Fit most desks, multifunction tables, and flip tables

Model #	Description	Size	List Price
FMP48WH	Flip Modesty Panel for 48" and 54" Tables	47.5"W x 11.5"H	468.00
FMP60WH	Flip Modesty Panel for for 60" and 66" Tables	59.5"W x 11.5"H	510.00
FMP72WH	Flip Modesty Panel for 72" Table	71.5"W x 11.5"H	505.00
MPP48WH	Privacy Modesty Panel 48" and 54" Tables	47.5"W x 23.5"H	416.00
MPP60WH	Privacy Modesty Panel for for 60" and 66" Tables	59.5"W x 23.5"H	512.00
MPP72WH	Privacy Modesty Panel for 72" Table	71.5"W x 23.5"H	611.00



AKDWMCSL

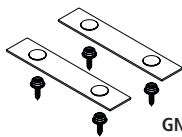

GNG1

Model #	Description	Size	List Price
AKDWMCSL	Akord Wire Management Cover Finish: Silver	2.25"W x 18"H x .25"D	131.00
GNG1	Akord Ganging Connectors 5 sets	5"W x 7"D	209.00



Laminate + Matching Edge Color Option



Base Options

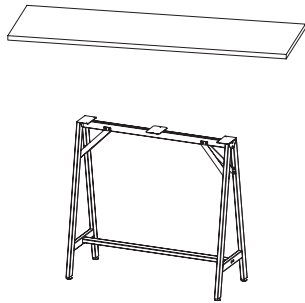
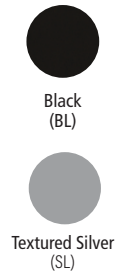





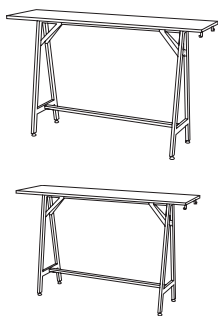

Jibe Top SKU # Formula

Model	Top Width	Top Depth	Top Shape	Base Color	Top Color/Pattern
JBEAFB	60 - 60" 72 - 72"	20 - 20" 24 - 24"	REC - Rectangle	BL - Black SL - Silver	See above for HPL laminate
J B E A F B +	6 0 +	2 0 +	R E C +	B L +	A S N T

Ex: JBEAFB6020RECBLASNT – Jibe 60x20" Top in Asian Night with Black Base

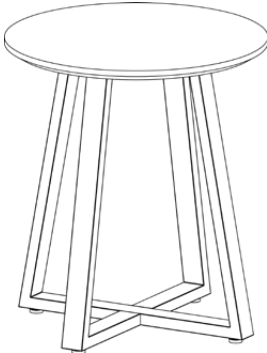

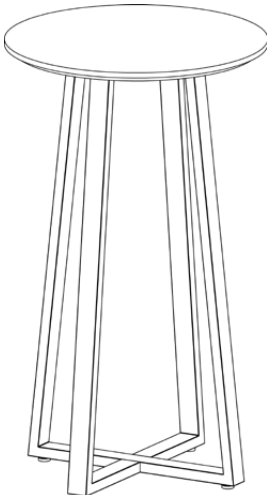
Model	Description	Model	List Price
JBEAFB6020REC	Jibe 60"W x 20"D x 42"H A-Frame Bar Height	JBEAFB6020REC	1,023.00
JBEAFB6024REC	Jibe 60"W x 24"D x 42"H A-Frame Bar Height	JBEAFB6024REC	1,136.00
JBEAFB7220REC	Jibe 72"W x 20"D x 42"H A-Frame Bar Height	JBEAFB7220REC	1,213.00
JBEAFB7224REC	Jibe 72"W x 24"D x 42"H A-Frame Bar Height	JBEAFB7224REC	1,349.00

	Parent #	Description	Model #	List Price
	<p>KVGCOF30RND</p> 	<p>Coffee Table Overall : 30"W x 30"D x 16"H MPIBU - Maple Top, Blue Base WLGN - Walnut Top, Green Base WLWH - Walnut Top, White Base</p>	<p>KVGCOF30RNDMPIBU KVGCOF30RNDWLGN KVGCOF30RNDWLWH</p>	<p>750.00</p>
	<p>KVGEND22RND</p> 	<p>End Table Overall : 22"W x 22"D x 25"H MPIBU - Maple Top, Blue Base WLGN - Walnut Top, Green Base WLWH - Walnut Top, White Base</p>	<p>KVGEND22RNDMPIBU KVGEND22RNDWLGN KVGEND22RNDWLWH</p>	<p>675.00</p>
	<p>KVGBAR24RND</p> 	<p>Bar Table Overall : 24"W x 24"D x 41"H MPIBU - Maple Top, Blue Base WLGN - Walnut Top, Green Base WLWH - Walnut Top, White Base</p>	<p>KVGBAR24RNDMPIBU KVGBAR24RNDWLGN KVGBAR24RNDWLWH</p>	<p>900.00</p>

Parent #	Description	Model #	List Price
----------	-------------	---------	------------

IDYA WHITEBOARD COLLECTION

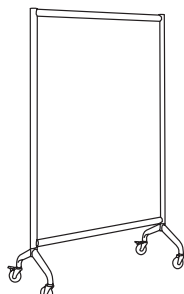

IDYWB3654SL	Mobile Whiteboard Screen Overall Size: 36"W x 16"D x 54"H	IDYWB3654SL	2,400.00
--------------------	---	-------------	----------

IDYWB4254SL	Mobile Whiteboard Screen Overall Size: 42"W x 16"D x 54"H	IDYWB4254SL	2,500.00
--------------------	---	-------------	----------

IDYWB3666SL	Mobile Whiteboard Screen Overall Size: 36"W x 16"D x 66"H	IDYWB3666SL	2,600.00
--------------------	---	-------------	----------

IDYWB4266SL	Mobile Whiteboard Screen Overall Size: 42"W x 16"D x 66"H	IDYWB4266SL	2,700.00
--------------------	---	-------------	----------



IDYERAGR	Screen Eraser Tray	IDYERAGR	50.00
-----------------	---------------------------	----------	-------

LIGHTING

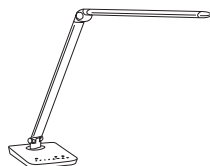

LULDLP	Lulli LED Desk Lamp 5"W x 16"D x 16.75"H Finish: Black-BL, Silver-SL, White-WH	LULDLPBL LULDLP SL LULDLPWH	300.00
---------------	---	-----------------------------------	--------

AJUSTABLE-HEIGHT DESKTOP

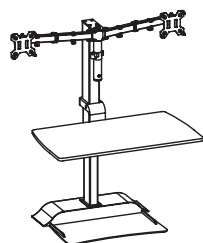

ACCSSEWH	Accend Electric Desktop Sit/Stand Dual Monitor Arms Overall: 27.75"W x 22"D x 18.5 - 37.25"H Finish: White-WH	ACCSSEWH	1,900.00
-----------------	---	----------	----------

MOBILE CHAIR CART

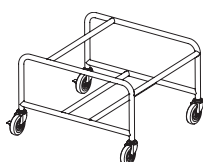

CRTSLDSL	Sled Base Stacking Chair Cart Can stack 20 units depending on the chair Overall: 23.5"W x 27.5"D x 17"H	CRTSLDSL	245.00
-----------------	--	----------	--------

Color Options



Onyx
(ONYX)



Graphite
(GRPT)



Granite
(GRNT)



Midnight Blue
(MNBL)



Cream
(CRME)

- All models have Blade Feet: 2.25"W x 18"D x .375"H
- Matrix and Chain Patterns are PET Material

Parent #	Description	Model #	List Price
----------	-------------	---------	------------

FREESTANDING SPACE DIVIDERS

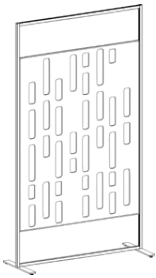

Parent #	Description	Model #	List Price
FSDMX	Matrix Pattern		
	Screen Size: 36"W x 72"H	FSDMX3672	5,288.00
	Screen Size: 48"W x 72"H	FSDMX4872	5,526.00
	Screen Size: 36"W x 84"H	FSDMX3684	5,831.00
	Screen Size: 48"W x 84"H	FSDMX4884	6,069.00

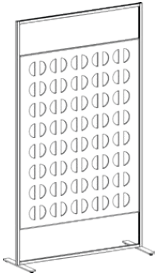

Parent #	Description	Model #	List Price
FSDCN	Chain Pattern		
	Screen Size: 36"W x 72"H	FSDCN3672	5,288.00
	Screen Size: 48"W x 72"H	FSDCN4872	5,526.00
	Screen Size: 36"W x 84"H	FSDCN3684	5,831.00
	Screen Size: 48"W x 84"H	FSDCN4884	6,069.00

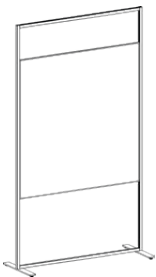

Parent #	Description	Model #	List Price
FSDMB	Markerboard Surface		
	Screen Size: 36"W x 72"H	FSDMB3672	5,387.00
	Screen Size: 48"W x 72"H	FSDMB4872	5,523.00
	Screen Size: 36"W x 84"H	FSDMB3684	5,856.00
	Screen Size: 48"W x 84"H	FSDMB4884	5,992.00

Model	Width	Height	Pattern Color
FSDMX - Matrix Pattern	36	72	ONYX-Onyx
FSDCH - Chain Pattern	48	84	GRPT-Graphite
FSDMB - Marker Board			GRNT-Granite
			MNBL-Midnight Blue
			CRME-Cream
			*Leave Blank (omit) for Marker Board Models
Example:			
F _ S _ D _ M _ X _ +	3 _ 6 _ +	7 _ 2 _ +	G _ R _ N _ T

Color Options



Granite
(GRNT)



Graphite
(GRPT)

- PET Material
- Handle Cutout 2" Radius
- Feet: 4" W x 2" H
- Available in Granite and Graphite

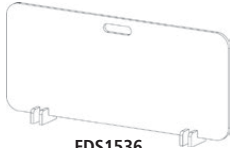

FDS1536



FDS1548

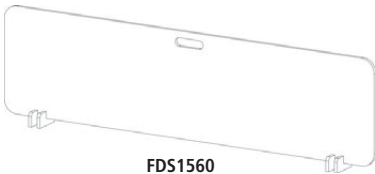

FDS1560



FDS1572

Parent #	Description	Model #	List Price
Desktop Privacy Screens			
FDS1536	Screen Size: 36"W x 15"H	FDS1536	521.00
FDS1548	Screen Size: 48"W x 15"H	FDS1548	552.00
FDS1560	Screen Size: 60"W x 15"H	FDS1560	609.00
FDS1572	Screen Size: 72"W x 15"H	FDS1572	643.00

Model	Color
FDS1536 - Desk Screen 36"	GRNT-Granite
FDS1548 - Desk Screen 48"	GRPT-Graphite
FDS1560 - Desk Screen 60"	
FDS1572 - Desk Screen 72"	
Example:	
F _ D _ S _ 1 _ 5 _ 3 _ 6 _ +	G _ R _ N _ T _

Laminate + Matching Edge Color Option



Base Options



- 36" lockers available with two 18" doors with internal dividing shelf
- Keyed (random - master key available) or Digital Locks (revolving code)
- Individual locker modules ship fully assembled
- Concealed adjustable door hinges
- Work surfaces are constructed with 1.125" particle board with HPL and 3mm PVC edge banding
- 4 leveling glides for easy alignment (per locker)
- Ganging hardware included for front to back, side to side, and top to bottom connection
- Optional toe-kick for use with UNYLOCFS18 & UNYLOCFS36
- All steel is finished with powder coat paint (white or textured black)

Laminate Edge Type

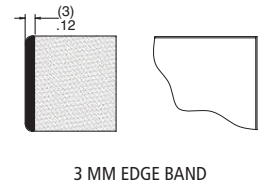

Fabric Options



Parent # Description Model # List Price

FREE STANDING LOCKERS

UNY01 Bench with Cushion* CC01 4,612.00

NEW PROP 65 ANGL STRIP
Locker Height: 18.5"
Seat Size: 60"W x 18"D
Overall Size: 60"W x 18"D x 20.5"H

Upcharge

Door Material Steel or Laminate (HPL) N/C
Lock Type
Keyed Lock N/C
Digital Lock - DL (Price is Per Lock) 106.00
Metal Color
White Powder Coat N/C
Black Textured Powder Coat N/C

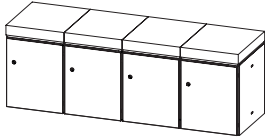

Model	Description	Cabinet Color	Door Material	Door Color	Lock Type	Fabric
UNY01	Bench Straight w/Cushion	WH - White BL - Black Textured	STE - Steel LAM - Laminate	See page 29 for laminate with matching edgeband choices	KD - Keyed Lock DL - Digital Lock	See page 29 for fabric options
UNY01 +		BL +	LAM +	CLWN +	DL +	OR11

STAND-ALONE LOCKER OPTIONS

UNYLOCFS18 18" Single Locker CCL18C 880.00

NEW PROP 65 ANGL STRIP
Overall Size: 15"W x 18"D x 18.5"H

Upcharge

Door Material Steel N/C
Lock Type
Keyed Lock N/C
Digital Lock - DL (Price is Per Lock) 106.00
Metal Color
White Powder Coat N/C
Black Textured Powder Coat N/C

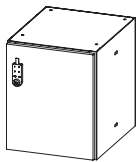

UNYLOCFS36 36" Single Locker CCL36C 1,639.00

NEW PROP 65 ANGL STRIP
Overall Size: 15"W x 18"D x 36.5"H
Number of Doors for 36" Lockers
Double Door - DD

Upcharge

Door Material Steel N/C
Lock Type
Keyed Lock N/C
Digital Lock - DL (Price is Per Lock) 106.00
Metal Color
White Powder Coat N/C
Black Textured Powder Coat N/C

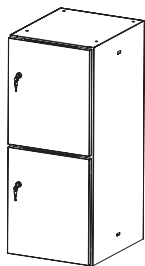

Model	Number of Doors*	Cabinet Color	Door Material	Door Color	Lock Type
UNYLOCFS18 UNYLOCFS36	DD-Double Door SD-Single Door	WH - White BL - Black Textured	STE - Steel LAM - Laminate	See page 29 for laminate with matching edgeband choices	KD - Keyed Lock DL - Digital Lock
UNYLOCFS36 +	DD +	BL +	LAM +	DSWT +	KD

*Single Door (SD) only available on UNYLOCFS36

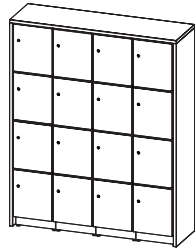

Parent #	Description	Model #	List Price
UNY06	Locker Wall Overall Size: 62.5"W x 18.5"D x 77.5"H Number of Doors for 36" Lockers Double Door - DD	CC06	15,687.00
			Upcharge
	Door Material Steel		N/C
	Lock Type		N/C
	Keyed Lock		N/C
	Digital Lock - DL (Price is Per Lock)		106.00
	Metal Color		N/C
	White Powder Coat		N/C
	Black Textured Powder Coat		N/C

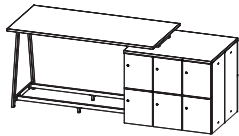

UNY08	A-Frame w/Riser (Long) Counter Size: 75"W x 37"D Locker Surface Height: 37.75"H Overall Size: 105"W x 37"D x 41.5"H Number of Doors for 36" Lockers Double Door - DD	CC08	15,244.00
			Upcharge
	Door Material Steel		N/C
	Lock Type		N/C
	Keyed Lock		N/C
	Digital Lock - DL (Price is Per Lock)		106.00
	Metal Frame Color		N/C
	White Powder Coat		N/C
	Black Textured Powder Coat		N/C

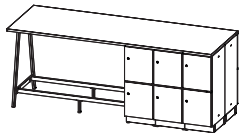

UNY10	A-Frame Bistro (Long) Counter Size: 105"W x 37"D Overall Size: 105"W x 37"D x 41.5"H Number of Doors for 36" Lockers Double Door - DD	CC10	15,103.00
			Upcharge
	Door Material Steel		N/C
	Lock Type		N/C
	Keyed Lock		N/C
	Digital Lock - DL (Price is Per Lock)		106.00
	Metal Frame Color		N/C
	White Powder Coat		N/C
	Black Textured Powder Coat		N/C

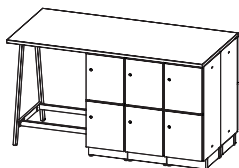

UNY11	A-Frame Bistro (Short) Counter Size: 75"W x 37"D Overall Size: 75"W x 37"D x 41.5"H Number of Doors for 36" Lockers Double Door - DD	CC11	13,415.00
			Upcharge
	Door Material Steel		N/C
	Lock Type		N/C
	Keyed Lock		N/C
	Digital Lock - DL (Price is Per Lock)		106.00
	Metal Frame Color		N/C
	White Powder Coat		N/C
	Black Textured Powder Coat		N/C

Model	Description	Base Color	Worksurface and Waterfall Color (HPL)	Number of Doors	Door Material	Door Color (HPL only)	Lock Type
UYN06	Straight Locker Wall	WH - White	See page 29 for laminate with matching edgeband choices	DD - Double Door	STE - Steel	See page 29 for laminate with matching edgeband choices	KD - Keyed Lock
UYN08	Bistro/Counter w/Riser 75" x 37"	BL - Black Textured		SD - Single Door	LAM - Laminat		DL - Digital Lock
UYN10	Bistro/Counter w/o Riser 105" x 38"					*for Steel Door (STE), leave blank	
UYN11	Bistro/Counter w/o Riser 75" x 39"						
Example: U Y N 0 6 +		B L +	O R 1 8 +	D D +	L AM+	O R 1 8 +	D L

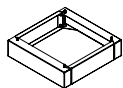

UNYTKC	Toe-Kick Option for UNYLOCF518 & UNYLOCF536 Overall Size: 15"W x 15"D x 3.625"H Finish: Black Textured-BL, White-WH	UNYTKCBL UNYTKCWH	132.00



REPLACEMENT KEYS			
	Replacement Key 201-300*		39.00
	920000462 Master Key		39.00
	* When requesting a replacement key the lock/key number, located on the face of the lock, is required		

Parent #	Description	Model #	List Price
----------	-------------	---------	------------

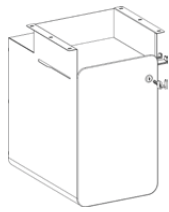

VYBLOCSU	Vybe Under Mount Desk Storage 14.4"W x 15.9"D x 19.4"H Granite grey felt door on white metal locker- GRNTWH Graphite felt door on black metal locker- GRPTBL	VYBLOCSUGRNTWH VYBLOCSUGRPTBL	430.00
-----------------	--	----------------------------------	--------



MOBCART	Mobee Open Shelf Mobile Cabinet 18.1"W x 11.4"D x 23.9"H White with Walnut top- WLWH	MOBCARTWLWH	450.00
----------------	--	-------------	--------

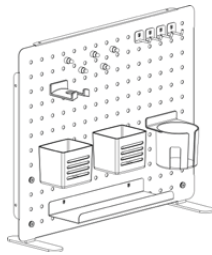

FRSVERTPB	Freestanding Desk Pegboard w/Storage Kit 20.5"W x 6.2"D x 16.9"H White- WH , Black- BL	FRSVERTPBWH FRSVERTPBBL	150.00
------------------	---	----------------------------	--------





ATDVDRMO	Atytude Storage Trolley w/Drawers 35.4"W x 15.8"D x 27.6"H White with white top- WHWH	ATDVDRMOWHWH	1,600.00
-----------------	---	--------------	----------

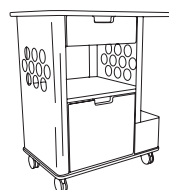

ATDHDRMO	Atytude Storage Trolley w/Lateral Drawers 35.4"W x 15.8"D x 27.6"H White with white top- WHWH	ATDHDRMOWHWH	1,600.00
-----------------	---	--------------	----------



SPHRSCWH	Sphyr Rolling Storage Cart Overall Size: 28"W x 20"D x 33.5"H Work Surface: 28"W x 20"D Slide-Out Drawers: 15.75"W x 15.75"D x 5"H 15.75"W x 15.75"D x 13.375"H Side Compartment: 5.5"W x 17.5"D x 7"H Finish: Silver Frame with White Top- WH	SPHRSCWH	1,720.00
-----------------	--	----------	----------

Parent #	Description	Model #	List Price
	STRHRC  Half Round Receptacle 23 Gallon Capacity 10.25"W x 20.25"D x 32.25"H Finish: White-WH, Silver-SL	STRHRCWH STRHRCSL	1,050.00
	Optional Vinyl Lettering	Upcharge	73.00

	STRRCN  Rectangular Receptacle 29 Gallon Capacity 10.25"W x 20.25"D x 32.25"H Finish: White-WH, Silver-SL	STRRCNWH STRRCNSL	1,050.00
	Optional Vinyl Lettering	Upcharge	73.00

OPTIONAL VINYL LETTERING			
CANS	LANDFILL	PLASTIC BOTTLES	TRASH
CANS AND BOTTLES	MIXED RECYCLING	PAPER	WASTE
COMPOST	ORGANICS	PLASTIC	

	STRTOP  Topper Lid 10"W x 20"D x 8.75"H Finish: White-WH, Silver-SL	STRTOPWH STRTOPSL	300.00
	Optional Vinyl Decals	Upcharge	73.00

OPTIONAL VINYL DECALS					
					
CANS	CANS AND BOTTLES	COMPOST	LANDFILL	MIXED RECYCLING	
					
ORGANICS	PLASTIC BOTTLES	PAPER	PLASTIC	TRASH	WASTE

	STRLID  Rectangular Lid 10"W x 20"D x .75"H Finish: White-WH, Silver-SL	STRLIDWH STRLIDSL	300.00
---	---	----------------------	--------

	STRHRLBL  Half Round Plastic Liner 21 Gallon Capacity 8"W x 16.75"D x 30.5"H Finish: Black-BL	STRHRLBL	210.00
---	--	----------	--------













	STRRCLBL  Rectangular Plastic Liner 27 Gallon Capacity 8.75"W x 16.75"D x 30.5"H Finish: Black-BL	STRRCLBL	210.00
---	--	----------	--------

Modix System Collection

Coming Soon!

Laminate + Matching Edge Color Option

Powder Coat

						
Asian Night (ASNT)	Battleship (BTTL)	Biltmore Cherry (BMCH)	Black (BLAK)	Carbon Mesh (CARM)	White (WHIT)	Mist (MIST)
						
Columbian Walnut (CLWN)	Designer White (DSWT)	Fashion Gray (FNGY)	Field Elm (FLEL)	Fusion Maple (FUMP)	Tech Silver (TKSV)	Corporate Sand (CSAN)
						
Landmark Wood (LDMK)	Pepperdust (PPDS)	Pinnacle Walnut (PNWN)	Portico Teak (PRTK)	River Cherry (RVCH)	Sand Beige (SDBE)	Desert Sage (DESA)
						
					Blue Medium (BLMD)	Textured Gray (GRAY)
						
					Black (BLCK)	Textured Black (TBLK)



MODIX DESK

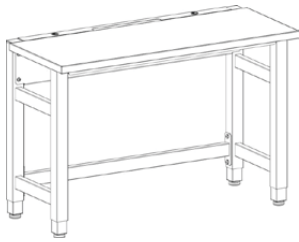

Model Number

Line	Type	Top Width	Top Depth	Shape
MDX - Modix	DSK - Desk	36 42 48 54 60 66 72	18 24 30 36	REC - Rectangle
Example:				
<u>M</u> <u>D</u> <u>X</u> +	<u>D</u> <u>S</u> <u>K</u> +	<u>4</u> <u>2</u> +	<u>1</u> <u>8</u> +	<u>R</u> <u>E</u> <u>C</u> +

Configured Options

Casters/Glides	Base Color	Top Surface Material	HPL Color Options (H3)
CA - Casters GL - Glides	See previous page for powder coat choices	H3 - HPL	See previous page for HPL laminate with matching 3mm edgeband choices
Example:			
<u>C</u> <u>A</u> +	<u>M</u> <u>I</u> <u>S</u> <u>T</u> +	<u>H</u> <u>3</u> +	<u>B</u> <u>L</u> <u>A</u> <u>K</u>

MODIX RETURN

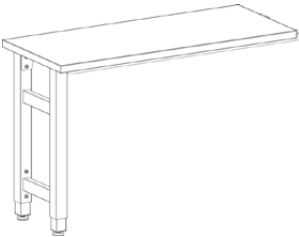

Model Number

Line	Type	Top Width	Top Depth	Shape
MDX - Modix	RTN - Return	36 42	18 24	REC - Rectangle
Example:				
<u>M</u> <u>D</u> <u>X</u> +	<u>R</u> <u>T</u> <u>N</u> +	<u>4</u> <u>2</u> +	<u>1</u> <u>8</u> +	<u>R</u> <u>E</u> <u>C</u> +

Configured Options

Glides	Base Color	Top Surface Material	HPL Color Options (H3)
GL - Glides	See previous page for powder coat choices	H3 - HPL	See previous page for HPL laminate with matching 3mm edgeband choices
Example:			
<u>G</u> <u>L</u> +	<u>M</u> <u>I</u> <u>S</u> <u>T</u> +	<u>H</u> <u>3</u> +	<u>B</u> <u>L</u> <u>A</u> <u>K</u>

MODIX TABLE

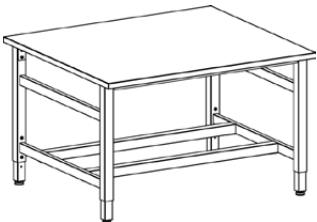

Model Number

Line	Type	Top Width	Top Depth	Shape
MDX - Modix	TBL - Table	48 60 72 84	24 30 36 42 48	REC - Rectangle
Example:				
<u>M</u> <u>D</u> <u>X</u> +	<u>T</u> <u>B</u> <u>L</u> +	<u>4</u> <u>8</u> +	<u>2</u> <u>4</u> +	<u>R</u> <u>E</u> <u>C</u> +

Configured Options

Casters/Glides	Base Color	Top Surface Material	HPL Color Options (H3)
CA - Casters GL - Glides	See previous page for powder coat choices	H3 - HPL	See previous page for HPL laminate with matching 3mm edgeband choices
Example:			
<u>C</u> <u>A</u> +	<u>M</u> <u>I</u> <u>S</u> <u>T</u> +	<u>H</u> <u>3</u> +	<u>B</u> <u>L</u> <u>A</u> <u>K</u>

MODIX UPPER FRAME



Model Number

Line	Type	Top Width	Height
MDX - Modix	UPF - Upper Frame	36 42 48 54 60 66 72	24 36 48
Example:			
<u>M</u> <u>D</u> <u>X</u> +	<u>U</u> <u>P</u> <u>F</u> +	<u>4</u> <u>8</u> +	<u>2</u> <u>4</u> +

Configured Options

Color
See previous page for powder coat choices
Example:
<u>M</u> <u>I</u> <u>S</u> <u>T</u> +

Model No.	Page	Model No.	Page	Model No.	Page
ACCSSEWH.....	27	FMP60WH	24	PWREXT	24
ACZ4LGP	12	FMP72WH	24	PWRISBL.....	24
ACZ4LGU	12	FRSVERTPB	33	PWRISDCBL	24
ACZBSTP.....	14	FSDCN	28	PWRISDCWH.....	24
ACZBSTU.....	14	FSDMB	28	PWRISWH	24
ACZECHP.....	14	FSDMX	28	PWRUSBACBL	24
ACZECHU.....	14	GNG1.....	24	PWRUSBACWH	24
ACZSLDP	12	IDYERAGR	27	REPLACEMENT KEYS.	32
ACZSLDU	12	IDYWB3654SL	27	SPHRSCWH.....	33
ACZTCHP.....	13	IDYWB3666SL	27	STRHRC	34
ACZTCHU.....	13	IDYWB4254SL	27	STRHRLBL.....	34
ACZTSTP	13	IDYWB4266SL	27	STRLID	34
ACZTSTU	13	JBEAFB	25	STRRCLBL.....	34
AKDCNF.....	23	JBEAFB6020REC.....	25	STRRCN	34
AKDDBB.....	23	JBEAFB6024REC.....	25	STRTOP	34
AKDDBS.....	23	JBEAFB7220REC.....	25	UNY01.....	31
AKDFLP	21	JBEAFB7224REC.....	25	UNY06	32
AKDFXP.....	22	KVGBAR24RND.....	26	UNY08	32
AKDFXT	21	KVGC0F30RND.....	26	UNY10.....	32
AKDWMCSL.....	24	KVGEND22RND.....	26	UNY11	32
AKDXBB.....	23	LULDLP	27	UNYLOCFS18.....	31
AKDXBS.....	23	MDX.....	36	UNYLOCFS36	31
ATDHDRMO	33	MOBCART.....	33	UNYTKC	32
ATDVDRMO	33	MPP48WH	24	VYBLOCSU	33
COHTCHUBL	18	MPP60WH	24	WELPRSUBL.....	18
COHTCHUBU.....	18	MPP72WH	24	WELPRSUBU	18
COHTCHUGR.....	18	MRJLGAU.....	19	WELPRSUGN	18
CRTSLDSL.....	27	MRJLGBU.....	19	WELPRSUGR.....	18
ECLGCHU.....	17	MRJLGLU.....	19		
ECLMCHU	17	MRJLGOU.....	19		
ECLTCHU	16	MRJLGRU.....	19		
ECLTSTU	17	MRJLGTU.....	19		
FDS1536.....	29	PWR110VBL.....	24		
FDS1548.....	29	PWR110VWH	24		
FDS1560.....	29	PWRDCSL	24		
FDS1572.....	29	PWREDGBL	24		
FMP48WH	24	PWREDGWH	24		

